

# IMPORTANCE OF INTEGRATED DFMA AND CAE IN DESIGN OF ACTUATOR HOUSING AND ITS EXPERIMENTAL VALIDATION

<sup>1</sup>S. Sudheer,<sup>2</sup>P. Karunakar,<sup>3</sup>G. Sunil Kumar

<sup>1,2,3</sup>Assistant Professor,

Department Of Mechanical Engineering

Christu Jyothi Institute Of Technology & Science, Colombo Nagar, Telangana

**Abstract** — Actuator housing is a critical aerospace component in rocket motor assembly, which houses the servo actuator, control fins and thrust vector controller. It has to satisfy number of critical parameters including Geometric Dimensioning and Tolerancing (GD&T) for easy manufacturing and smooth assembly, required strength against various loads acting on it during the flight trajectory, transportation and launching. Actuator housing is designed and developed with integrated Design for Manufacturing and Assembly (DFMA) principles and Computer Aided Engineering (CAE) techniques to improve the design features for ease of manufacturing and assembly. In this approach, the functional requirement of the manufacturer and the assembler are discussed with the designer and implemented at the preliminary design stage only. These enables the product outcome in lesser time with reduced cost by minimizing the manufacturing and assembly defects. CAE is carried on Actuator housing at various loads and boundary conditions in three loading cases satisfying factor of safety and mass, topology & strength optimizations. The experimental validation is carried on a prototype of the actuator housing with three loading condition cases (Transportation load, pitch, and yaw forces). The results of actuator housing against all the load cases are reiterated and optimized, these are within the material strengths factor of safety. It results improved the materials structural stability, strength and quality of the product satisfying all the flight trajectory conditions and missile direction configurations. These enables the mass production of the product with reduced cost, time and reaching the market in less time.

**Key Words:** Actuator Housing, design for manufacture and assembly, Computer Aided Engineering (CAE), Geometric Dimensioning and tolerancing.

## 1. INTRODUCTION

Design, Development and Productionization of aerospace components with high quality, at less cost and less time is the success key in the present competitive market. To overcome these issues aerospace manufacturing industries are focusing on latest trends and available CAE tools to design, analysis and optimize the product in virtual environment. Design for manufacturing and Assembly (DFMA) is the one of the best method to design the product by considering all manufacturing and assembly issues at early stage of design. DFMA comprises of Design for Manufacturing (DFM) and Design for Assembly (DFA). DFM concentrates on, how to reduce the manufacturing cost by using best manufacturing process & optimal process plan. DFA concentrates on, how to reduce number of parts without deviating from functional requirements to improve assembly index and assigning proper GD&T to control assembly fits and tolerances.

Actuator housing is designed using DFMA principles and analyzed using CAE tools, it provides complete coverage of preliminary design, modelling, analysis and optimization of actuator housing to get best design at less cost and high quality in shorter

time. Implementing the integrated DFMA and CAE analysis at early stage design gives best results.

## 2. LITERATURE REVIEW

A review paper stated that the industries are struggling high competition due to number of new products releasing in the market continuously. To sustain in the market, the product should be launched in the market as early as possible at high quality with less price. It can be possible by implementing DFMA method at design stage itself [1]. Majority of decisions were finalized at design phase itself, hence 80% of product cost is locked at design stage. The author Wankhade Nitesh Prakash, redesigned fluid flow control valve using DFMA method, that results reduced cost and increased the quality with in shorter time [2]. Giudice et. al., used the DFMA principles and Finite Element Analysis tools to improve design simultaneously. It minimizes the number of iterations, reduced the development time and cost effective as a proactive approach [3]. The author P.Selvaraj, [4] says that reduction of product development time and cost to meet present competitive environment is possible only by implementing DFMA at the designing of a new product design and development. It simplifies the design process and reduces the manufacturing time and cost and also optimize the process. The author Y

Ngatilah, emergency light was redesigned using light emitting diode (LED) applying DFMA method which results in improved assembly efficiency, increased the number of additional features, which are essential usage and also reduced the overall cost of emergency light [5]. Producibility and manufacturability of aerospace engine components are the major task within the shorter time and without increasing cost. The author Johan Vallhagena, discussed about the gaps identified and possible improvements through DFM techniques [6]. Barbose et. al. prepared some useful guidelines for aircraft design engineers to implement during design and development phase to achieve best design considering DFMA guidelines such as manufacturability, assemblability, maintenance and ergonomics [7]. The author Ejaz Salim, conducted customer survey on juicer mixer grinder considering DFMA principles [8], which is the most commonly used item in every house. Redesigned the Juicer mixer grinder with best manufacturing process for optimal cost and quality using DFMA principles and CAD tools. The frame work developed to facilitate new product induction through effective communication between designer, manufacturer and assembler using DFMA guidelines [9].

**3. DESIGN REQUIREMENTS OF ACTUATOR HOUSING**

Actuator Housing is one of the main sub-system in general missile configuration as shown in figure 1. Control fins are assembled to servo assembly and Servo assembly assembled to Actuator housing which is part of missile main body. It houses nozzle assembly, servo system, control fins and thrust vector controls to provide desired diction of missile. Actuator housing axis should be always in line with missile axis, then only the required force generated by controls and thrust force generated by nozzle to get desired direction of missile. Misalignment of nozzle axis and actuator axis are should be less than 5 mille-radians.

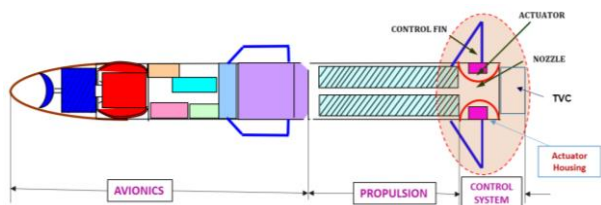

Figure 1 General Missile Configuration

Generally, the direction of Missiles or Aero Planes are controlled in three ways such as Pitch, Yaw and roll control in order to get desired path and to reach the destination as shown in figure 2.

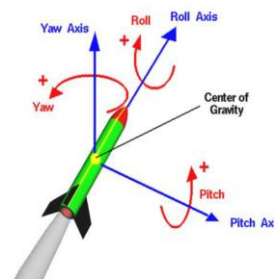

Figure 2 Missile Direction Controls about CG

Control fins are the main components to generate required force to move in desired directions with the help of Actuator assembly. The Actuator Housing is subjected to the Pitch and Yaw loads during the flight as shown in figure 3 and axial load during the transportation as shown in figure 7.

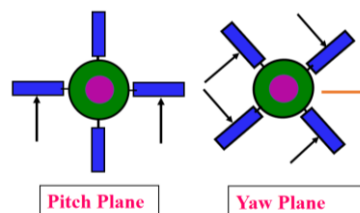

Figure 3 Types of Direction Controls

It should be in line with (missile axis) complete missile. The misalignment of Nozzle axis and actuator assembly with missile axis is very critical. The aerodynamic loads acting on controls fins are transferred through servo system to actuator housing. Hence the design of actuator housing extremely critical.

This research work will focus on Design and Development of Actuator Housing using Integrated DFMA principles and Computer Aided Engineering (CAE). Compares the conventional & integrated Design for Manufacture and Assembly (DFMA), CAE design approaches and validation of it with experimentation.

**4. DESIGN OF ACTUATOR HOUSING USING DFMA PRINCIPLES AND CAE**

Study the requirements of Actuator Housing and its functionality. The flow diagram of Design and

Development of Actuator Housing using DFMA Principles and CAE tools as shown in figure 4. The following design modifications are suggested based on DFMA principles.

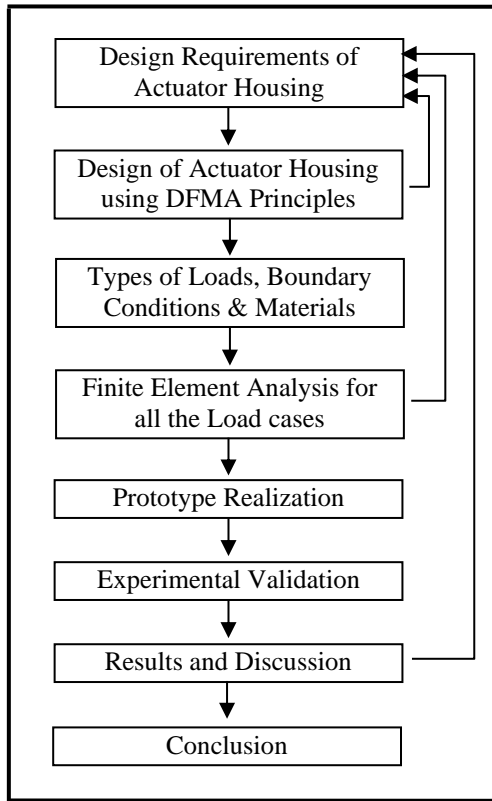

Figure 4 Integrated DFMA and CAE Design & Its Validation Methodology

Based on the summary of literature survey, early stage implementation of Design for Manufacturing and Assembly principle will result in assembly and manufacturing cost reduction, best product realized in shorter time with best price and product reaches user faster.

- DFMA not only reduces the manufacturing cost of the product but it helps to reduce the time to reach market and quality of the product.
- DFMA provides a systematic procedure for analyzing a proposed design from the point of view of assembly and manufacture.
- Any reduction in the number of parts reduces the cost as well as the inventory.
- DFMA tools encouraged the dialogue between the Designer, Manufacturer and Assembly engineers during the early stages of design.

[1]. Design for Assembly (DFA):

- Basic actuator housing was done based on the strength, functional requirements and availability of raw materials
- Allocation Tolerances based on Functionality, Manufacturability and ease of assembly.
- Study the effect of Geometric Tolerances on assembly Point of View.
- Stud joints are modified as a weld joint as shown in figure 5.

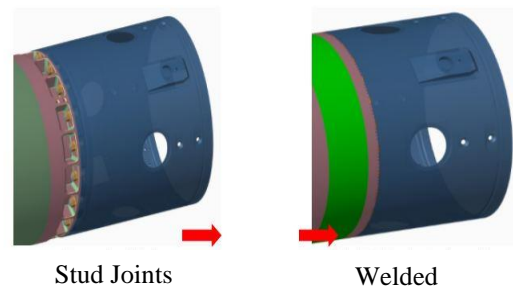

Figure 5 Simplified DFA Welded Actuator Housing

[2]. Design for Manufacturing (DFM):

- Materials selection based on functionality, cost and manufacturability.
- Outside projected Guide Boss is made separately and welded together for ease of manufacturing as shown in figure 6.
- Guide boss material is changed to high strength Maraging steel.

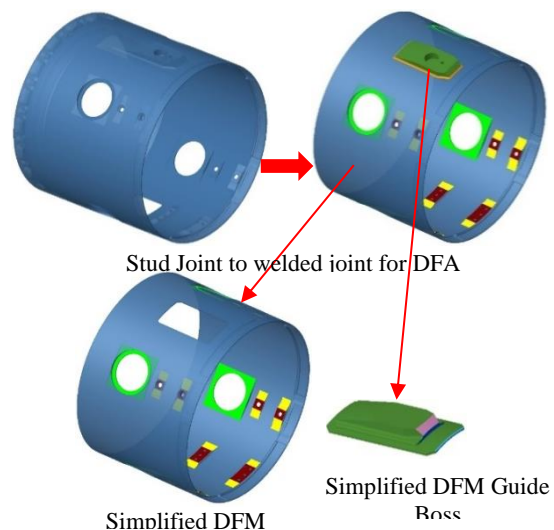

Figure 6 Simplified DFMA Actuator Housing

Implantation of DFMA principles by manufacturer and assembler, the design was modified for ease of manufacturing and assembly. The following changes are proposed from DFMA perspective.

- I. Aft End Skirt needs to be welded to Rocket Motor in place of stud joint
- II. Guide Boss separately manufactured with higher strength material and welded the Actuator housing in place of integral part of actuator housing low alloy steel.
- III. Improved the tolerancing by using GD&T for better understanding, machining and assembly.
- IV. Changed the raw material of Actuator housing
- V. Critical features are machined after welding the actuator housing to the Rocket Motor.

**5. TYPES OF LOADS, BOUNDARY CONDITIONS & MATERIALS**

Selection of raw material for actuator housing was based on the strength, heat treatment, weldability, cost, availability and ease of machining. The Actuator housing is made up of SAE 4130 Steel and its material properties at room temperature are tabulated in table 1.

Table 1 Material Properties

Temp . (°C)	UTS (MPa)	YS (MPa)	Young's Modulus(GPa)	Poisson's Ratio
RT	1050	910	214	0.3

**5.1 CASE – I: AXIAL LOAD**

Axial load is applied due to the movement, road damping's and other various disturbances during the transportation of the articles to the different remote locations as shown in figure 7.

- I. Axial Load on the boss is due to the external disturbance and the transportation = 42kN
- II. This load will be transferred to the actuator housing through Boss

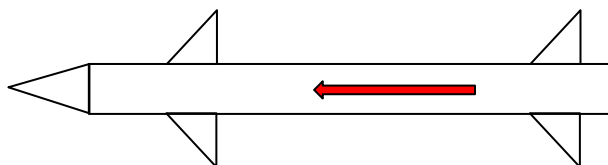

Figure 7 Axial Loading Configuration (Case-I)

**5.2 CASE – II: LOADING OF TWO FINS (PITCH)**

Pitching is upwards and downward movement of the missile on pitch axis, which is passing through center of gravity of the missile as shown in figure 8. The required pitch force is generated through two fins configuration.

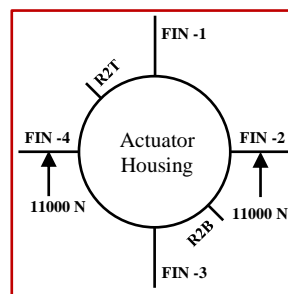

Figure 8 Pitch Loading Configuration (Case-II)

- I. In this case, it is considered that only two fins are loaded to maximum lift (Pitch) load of 11000 N.
- II. This load will be transferred to the actuator housing by means of bolts.

**5.3 CASE – III: LOADING OF FOUR FINS (YAW)**

Yaw load is the maximum turn load required from four fins configuration as shown in figure 9.

- I. In this case, it is considered that the two fins are loaded at 10200 N and other two fins are loaded at 4000 N to maximum turning load (Yaw).
- II. This load will be transferred to the actuator housing by means of bolts.

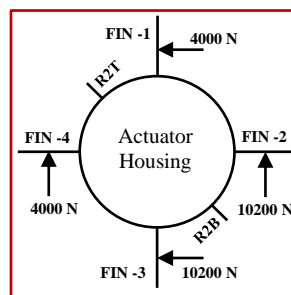

Figure 9 Yaw Loading Configuration (Case-III)

**6. FINITE ELEMENT ANALYSIS OF ACTUATOR HOUSING**

The Finite Element Analysis is a powerful tool used to analyze and optimize the design to find stresses and deflections of actuator housing. Structural analysis carried out at each load case to find out maximum stress levels, Deflection and factor of safety before the development of a prototype and load test to minimize the design cycle.

**6.1 FEA CASE – I: AXIAL LOAD**

Maximum Von Mises stress is found at weld joint of Guiding Boss due to change in geometry (stress riser), however it is local and very small area. The meshed model, boundary conditions, loads and von-misses stress are shown in the figure 10.

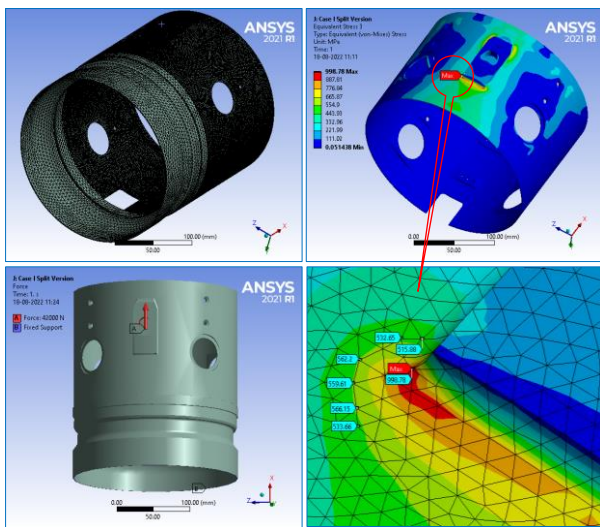

Figure 10 FEA model & Von Mises Stress of Case - I

Three locations are identified to bond strain gauges and monitor the strains during load test as shown in figure 11.

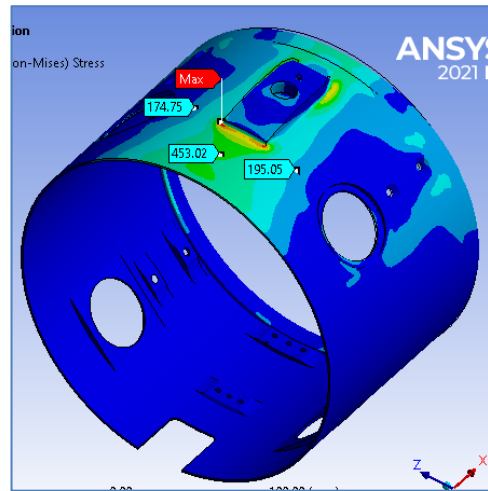

Figure 11 Von Mises Stress Locations for Strain Gauges (Case - I)

**6.2 CASE – II:**

Load is applied on two fins to generate required Maximum pitch force. Maximum Von Mises stress is found at edge of counter sunk screw hole due to change in geometry (stress riser), however it is local and very small area. The meshed model, boundary conditions, loads and von-misses stress are shown in figure 12.

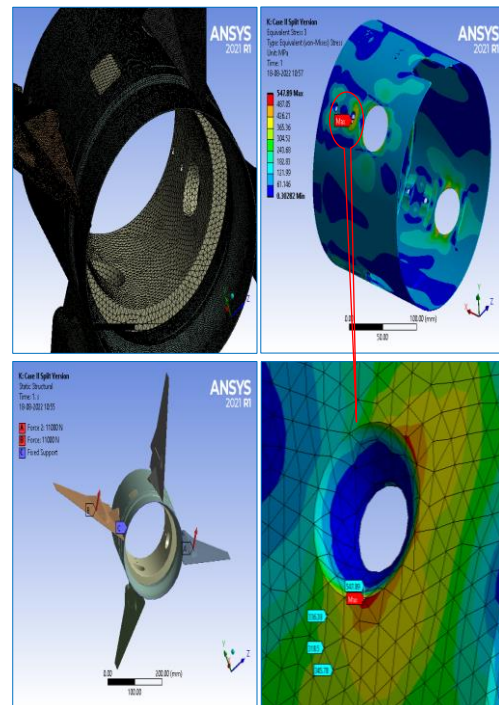

Figure 12 FEA model & Von Mises Stress of Case - II

Sixteen locations are identified to bond strain gauges around four fins cut outs on actuator housing to

monitor the strains during load tests are shown in figure 13.

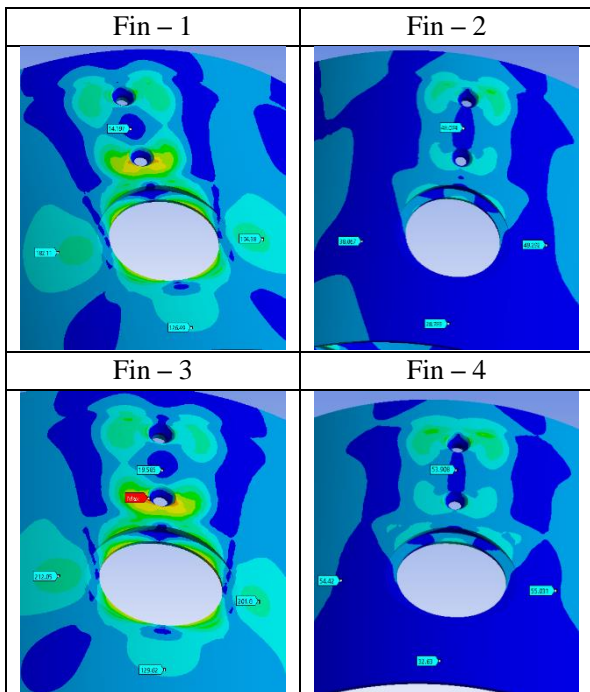

Figure 13 Von Mises Stress Locations for Strain Gauges (Case – II)

6.3 CASE – III

Load is applied on all four fins to generate required Yaw force. Maximum Von Mises stress is found at the edge of counter sunk screw hole due to change in geometry (stress riser), however it is local and very small area. The meshed model, boundary conditions, loads and von-misses stress are shown in figure 14.

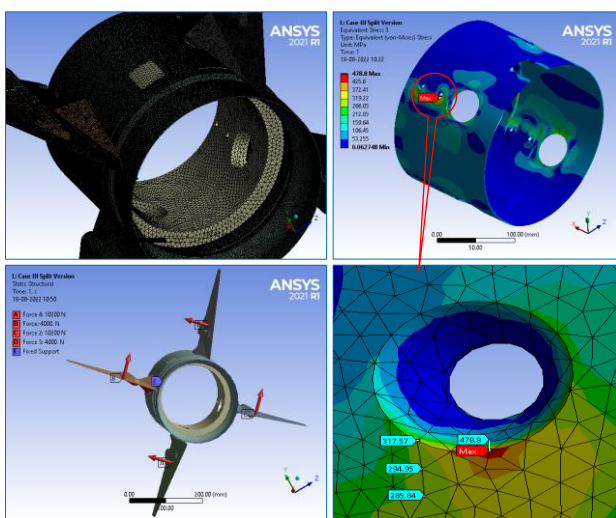

Figure 14 FEA model & Von Mises Stress of Case - III

Sixteen locations are identified to bond strain gauges around four fins cut outs on actuator housing to monitor the strains during load test are shown in figure 15.

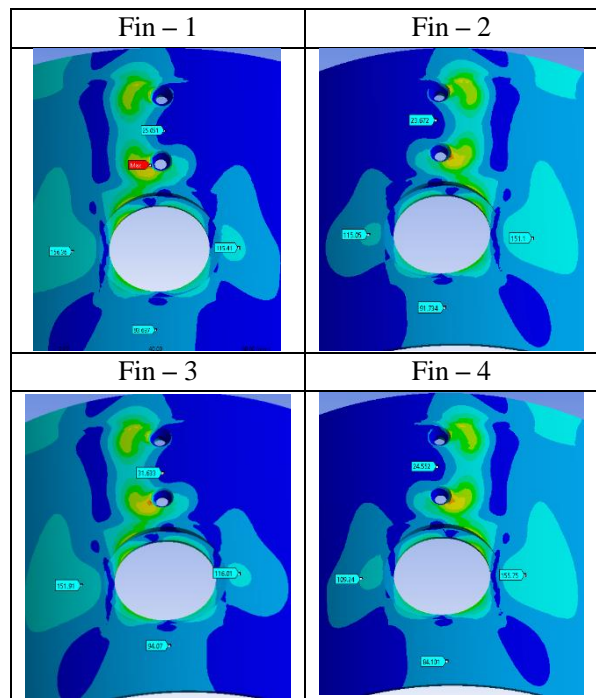

Figure 15 Von Mises Stress Locations for Strain Gauges (Case – III)

7. PROTOTYPE REALIZATION

Actuator Housing was designed by using Integrated DFMA methodology and CAE approach. The optimized Split Actuator Housing prototype was developed in two stages, in first stage Guiding Boss realized with MDN 250 materials and split actuators housing realized with SAE 4130 materials and in second stage both of them welded together as shown in figure 16. DFMA Design of actuator housing changed the 65% machining process from milling to turning. Which results in reduction of realization time & cost and also minimized cutting forces on the component, hence the deviations due distortion of component reduced and acceptance rate is increased.



Figure 16 Prototype of Actuator Housing (Split)

## 8. EXPERIMENTAL VALIDATION OF ACTUATOR HOUSING DESIGN

The experiments are conducted to validate the design and to prove the structural integrity of Actuator Housing due transportation load (Case-I) & control fins loads (Case-II&III). Actuator Housing is a cylindrical shell and Four circular holes have been provided for fins assembly. The configuration of Actuator Housing is shown in figure 1 for Case-I. Actuator Housing is welded to Dummy Motor Casing, Actuator block is attached to the Actuator Housing by bolts, fins are assembled to actuator block by bolts and the total assembly is fixed on the test fixture for Case-II and III. The Actuator Housing was tested upto proof load (112.5 times of design load). Load was applied in steps of 0-20-0-20-40-60-80-100-112.5-112.5-0 % of Design Load.

### 8.1 CASE – I

Actuator Housing was welded to a base plate and red die penetration test was carried out and found satisfactory. The Base plate attached to the test rig, 10-ton capacity pneumatic actuator connected to guiding boss hole for applying load, strain gauges bonded and LVDTs positioned at required places as shown in figure 17.



Figure 17 Experimental Setup for Case - I

### 8.2 CASE-II:

Actuator housing was welded to dummy motor casing, control fins and servo block assembled to actuator housing, LVDTs, Strain gauges and pneumatic actuator are positioned shown in figure 18 to apply pitch loads on two control fins of case - II to generate maximum pitch force.

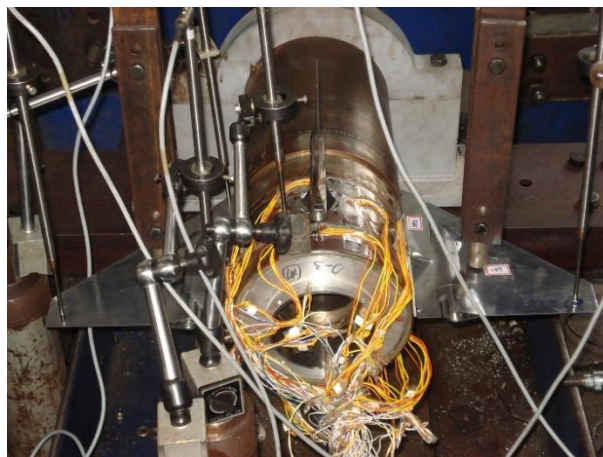

Figure 18 Experimental Setup for Case – II

### 8.3 CASE-III

Actuator housing was welded to dummy motor casing, control fins and servo block assembled to actuator housing, LVDTs, Strain gauges and pneumatic actuator are positioned shown in figure 19 to apply yaw loads on four control fins of case - III to generate maximum yaw force.



Figure 19 Experimental Setup for Case - III

## 9. RESULTS AND DISCUSSIONS

The experiments for all the load cases are conducted successfully and results are extracted.

- Actuator housing assembly withstood proof load of 112.5% without any visual failure.
- Von Mises stresses are calculated from principal stresses of all locations at proof load and all are within yield strength of the material.
- Young's Modulus and Poisson's ratio used for principal stress calculations are 21407 kg/mm<sup>2</sup> and 0.3 respectively.

d) The converted Von Mises stresses and Deflections plots of all the Cases at all locations are given in below.

9.1 CASE – I

Von Mises stress plot is shown in figure 20 up to proof load. The max Von Mises stress at Strain Gauge-1 was 463.7 MPa at Design Load and 516.35MPa at proof Load.

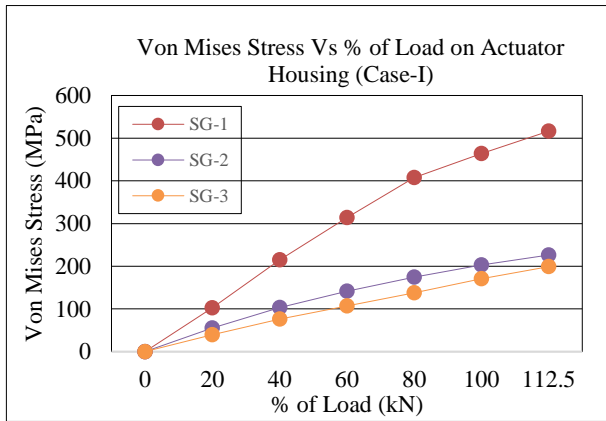

Figure 20 Stress Vs Load (Case-I)

Deflection plot is shown in figure 21 up to proof load. The max deflection at LVDT-2 was 2.5mm at Design Load and 2.87mm at proof Load.

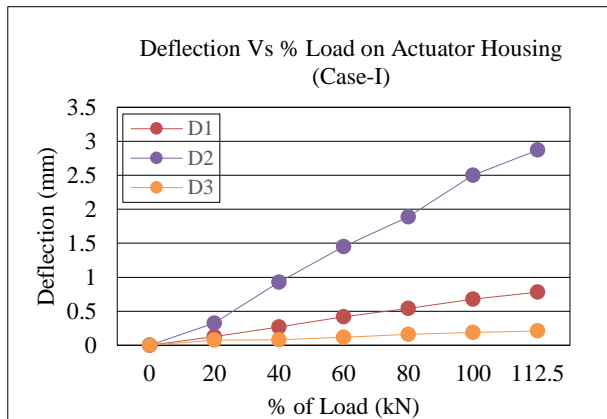

Figure 21 Deflection Vs Load (Case-I)

9.2 CASE – II

Von Mises stress plots at various fin locations are shown in figure 22 up to proof load. The max. Von Mises stress at Strain Gauge -3 at Fin -1 location was 211.95 MPa at Design Load and 244.74MPa at proof

Load.

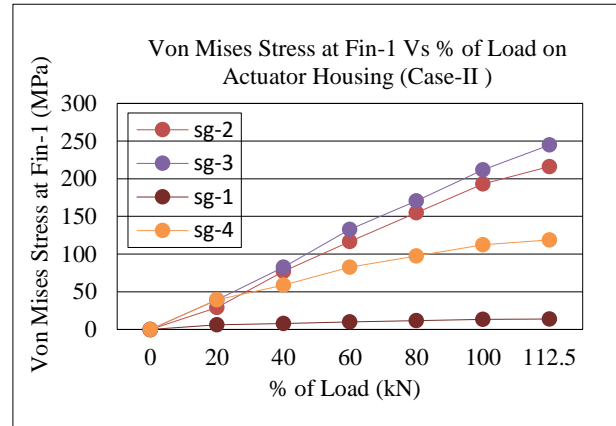

Figure 22 Stress at Fin-1 Vs Load (Case-II)

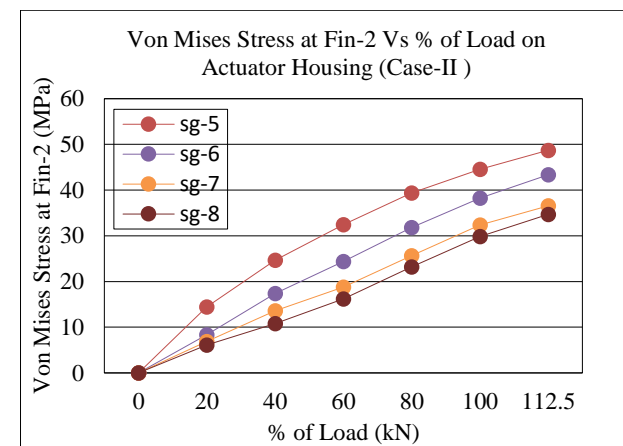

Figure 23 Stress at Fin-2 Vs Load (Case-II)

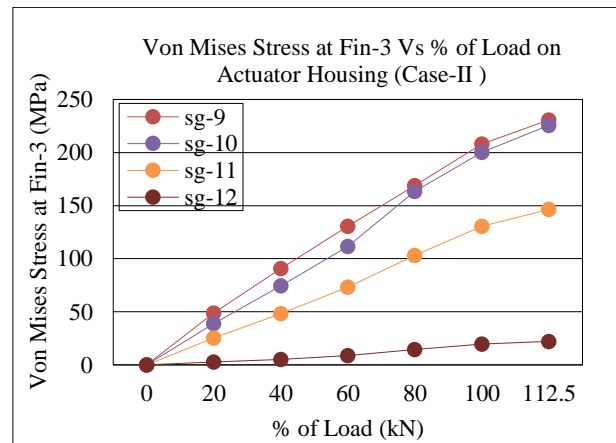

Figure 24 Stress at Fin-3 Vs Load (Case-II)



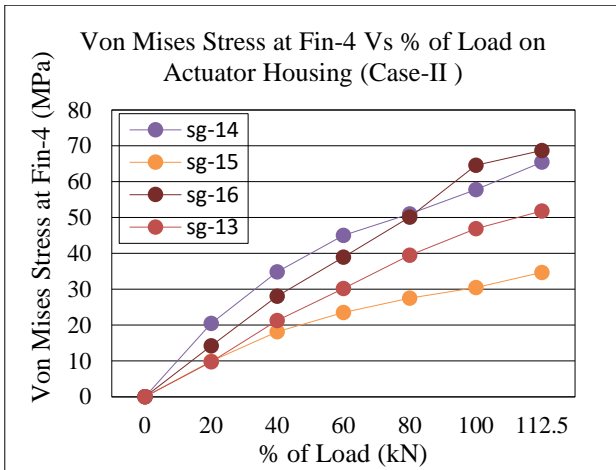

Figure 25 Stress at Fin-4 Vs Load (Case-II)

Deflection plot is shown in figure 26 up to proof load. The max. deflection at LVDT-1 was 0.849 mm at Design Load and 0.977 mm at proof Load.

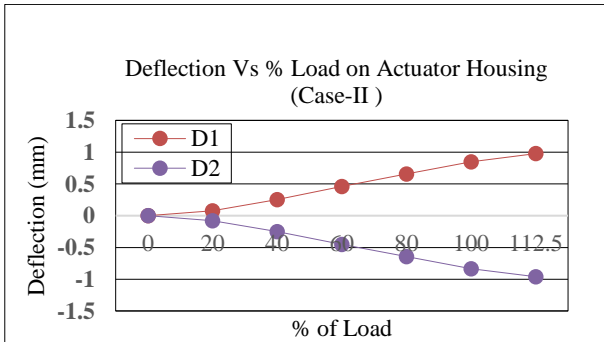

Figure 26 Deflection Vs Load (Case-II)

9.3 CASE-III

Von Mises stress plots at various fin locations are shown in figure 27 up to proof load. The max. Von Mises stress at Strain Gauge -10 at Fin -3 location was 159.63 MPa at Design Load and 176.94 MPa at proof Load.

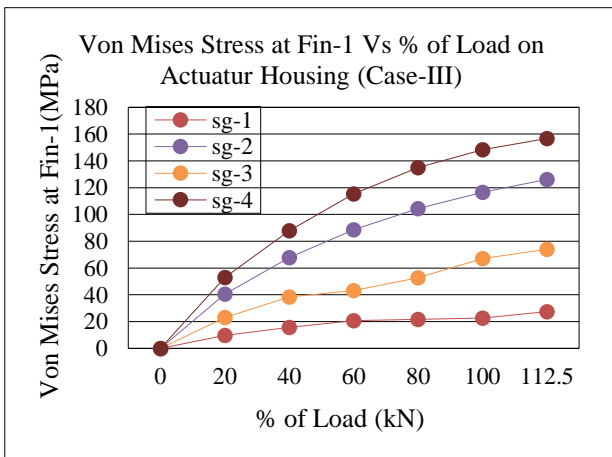

Figure 27 Stress at Fin-1 Vs Load (Case-III)

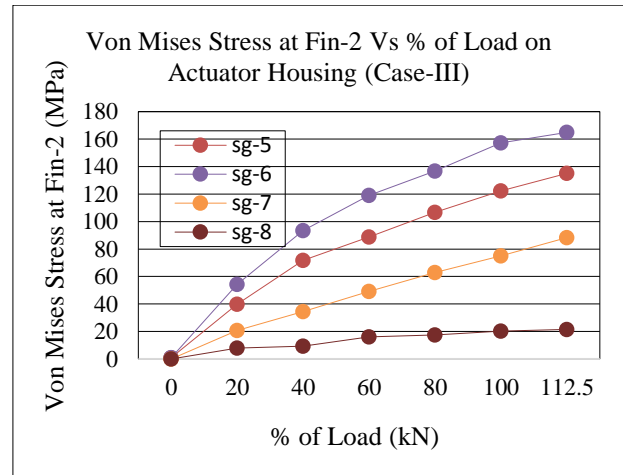

Figure 28 Stress at Fin-2 Vs Load (Case-III)

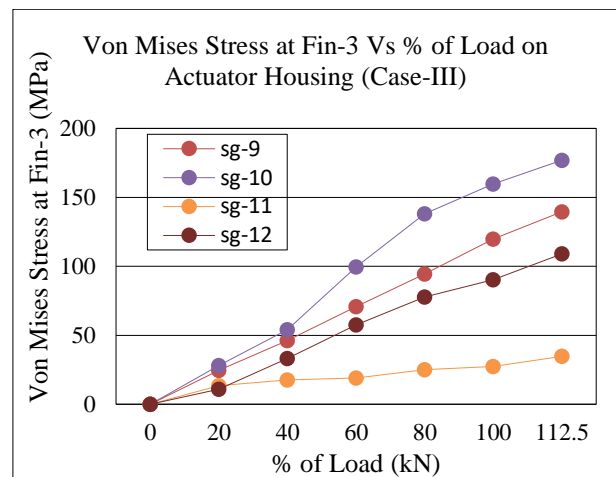

Figure 29 Stress at Fin-3 Vs Load (Case-III)

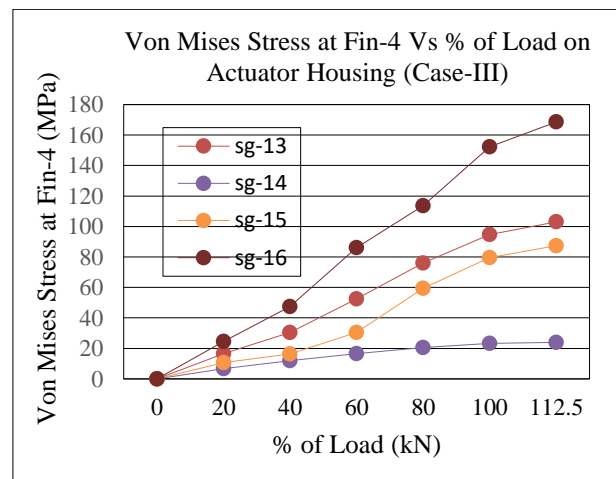

Figure 30 Stress at Fin-4 Vs Load (Case-III)

Deflection plot is shown in figure 31 up to proof load. The max deflection at LVDT-2 was 0.564 mm at Design Load and 0.662 mm at proof Load.

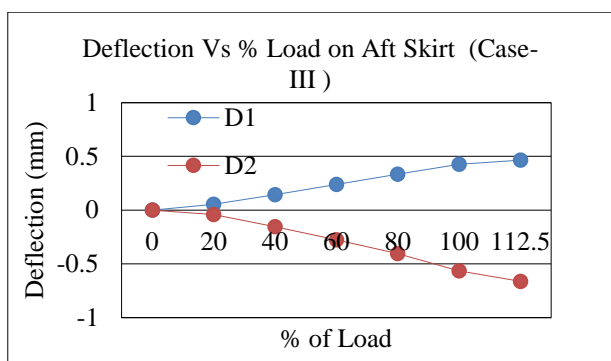

Figure 31 Deflection Vs Load (Case-III)

10. CONCLUSION

Implementation of integrated DFMA and CAE design methodology at preliminary design stage of actuator housing were resulted in reducing the design, development and its validation time. Thus minimized the Design and Development cost by avoiding number of iterations, reworks to suit assembly and man power. Experimental validation of Actuator Housing proved the way to integrated DFMA and CAE design methodology. Actuator Housing withstood proof load satisfactorily without any visual failure. Von Mises stresses are less than yield strength of material at proof load.

Finite Element Analysis is very powerful tool in Computer Aided Engineering. The Finite Element Analysis results are compared with experimental results at design load conditions for all the load cases are tabulated in table-3,4 and 5 and are close match.

Table 2 Comparison of Stress and Deflection (Case-I)

Case - I (at 100% Load)			
Von Mises Stress(MPa)		Deflection (mm)	
CAE	Experiment	CAE	Experiment
453	463.70	2.98	2.87
195	203.12	0.69	0.78
174	170.85	0.14	0.21

Table 3 Comparison of Stress and Deflection (Case-II)

Case - II (at 100% Load)			
Von Mises Stress (MPa)		Von Mises Stress(MPa)	
CAE	Experiment	CAE	Experiment
at Fin-1		at Fin-2	
14.19	13.27	49.29	44.56
182.11	193.32	48.07	38.23
194.38	211.95	38.06	32.34
126.49	112.17	28.78	29.87

at Fin-3		at Fin-4	
201.8	207.96	53.90	46.93
212.05	200.26	55.03	57.80
129.62	130.69	32.63	30.46
19.58	19.59	54.42	64.57
Deflection (mm)			
0.849		0.466	
-0.836		-0.502	

Table 4 Comparison of Stress and Deflection (Case-III)

Case - III (at 100% Load)			
Von Mises Stress (MPa)		Von Mises Stress(MPa)	
CAE	Experiment	CAE	Experiment
at Fin-1		at Fin-2	
25.00	22.56	115.05	122.22
115.40	116.56	151.10	157.21
73.70	67.20	91.73	75.09
156.30	148.40	23.60	20.27
at Fin-3		at Fin-4	
116.00	119.69	109.20	94.67
151.90	159.64	24.50	23.19
31.60	27.47	84.10	79.65
94.00	90.25	155.70	152.32
Deflection (mm)			
0.367		0.427	
-0.351		-0.564	

Table 5 Factor of Safety for Actuator Housing

Factor of safeties of Case-I, II and III are well within limits and satisfied the required design margins as per MIL Standard are tabulated in table-5.

Factor of Safety				
	Yield Strength (MPa)	Max. Stress (CAE) (MPa)	Stress Considered (MPa)	FOS on Yield
Case-I	910	998.78	566.15	1.60
Case-II	910	547.89	336.38	2.70
Case-III	910	478.8	294.95	3.08

11. ACKNOWLEDGEMENT:

The authors are sincere gratitude to the Director, Defence Research and Development Laboratory (DRDL), Hyderabad for giving opportunity to publish research work and also thankful to the Principal, Osmania University College of Engineering (OUCE),

Hyderabad for continuous encouragement throughout this work.

## 12. REFERENCES

- [1]. Naol Dessalegn Dejene, et. al. Design for Manufacturing and Assembly- Review. World Academics Journal of Engineering Sciences; Vol.7, Issue.3, pp.60-67; September 2020.
- [2]. Wankhade Nitesh Prakash, et. al. New product development by DFMA and Rapid Prototyping. ARPN Journal of Engineering and Applied Sciences; Vol. 9, No.3: March 2014.
- [3]. F. Giudice, F. Ballisteri, et. al. A Concurrent Design Method based on DFMA–FEA Integrated Approach. Concurrent Engineering: Research and Applications 2009; Vol. 17, No. 3.
- [4]. P. Selvaraj, et. al. An integrated approach to design for manufacturing and assembly based on reduction of product development time and cost. International Journal of Advanced Manufacturing Technology (2009) 42:13-29.
- [5]. Y Ngatilah, et. al. Design for Manufacture and Assembly for Product Development (Case study: Emergency Lamp). The 2nd International Joint Conference on Science and Technology (IJCST) 2017; IOP Conf. Series: Journal of Physics: Conf. Series 953 (2018) 012235.
- [6]. Johan Vallhagena, et.al. An approach for producibility and DFM-methodology in aerospace engine component development. 2nd International Through-life Engineering Services Conference, Procedia CIRP 11 (2013) 151-156.
- [7]. Barbosa, et. al. Design for Manufacturing and Assembly Methodology Applied to Aircrafts Design and Manufacturing. 22nd International Congress of Mechanical Engineering, November 3-7; Brazil: 2013.
- [8]. Ejaz Salim, et. al. Conceptualization, Design for Manufacture and Assembly (DFMA) of Juicer Mixer Grinder. Proceedings of National Conference on Advances in Mechanical Engineering “NCAME”/ SBCEC/23rd & 24th March 2011.
- [9]. A. Whiteside, et.al. Developing a Current Capability Design for Manufacture Framework in the Aerospace Industry. Proceedings of the 19th CIRP Design Conference – Competitive Design, Cranfield University 2009: pp223.
- [10]. LIU Shaochao, et. al. Collaborative Design and Manufacturing in Research Flowchart for Large Aircraft. Applied Mechanics and Materials Vols 88-89 (2011) pp 576-582.
- [11]. Sami Matthews, et.al. Formulation of novel DFMA rules for the advancement of ergonomic factors in non-linear iterative prototype assembly. International Journal of Computer Integrated Manufacturing (2018), 31:8, 777-784.
- [12]. Geoffrey Boothroyd, Peter Dewhurst, Winston A Knight. Product Design for Manufacture and Assembly. 3rd ed., CRC Press (2011) and Taylor & Francis Group LLC, Boca Raton, FL.
- [13]. Giovanni Formentini, et.al. Design for manufacturing and assembly methods in the product development process of mechanical products: a systematic literature-review. The International Journal of Advanced Manufacturing Technology (2022) 120:4307–4334.
- [14]. Harik RF, et.al. DFMA+, a quantitative DFMA methodology. Computer-Aided Design and Applications (2010) 7(5):701–709.
- [15]. Volotinen J, et. al. The re-design of the ventilation unit with DFMA aspects: case study in Finnish industry. Procedia Manufacturing (2018) 25:557–564.