

# GRAPHANE NANOPATES' EFFECT ON THE STRUCTURAL PROPERTIES OF AIRCRAFT FLAPS

<sup>1</sup>D. Venkata Ramana,<sup>2</sup>K. Madhu,<sup>3</sup>S. Sudheer

<sup>1,2,3</sup>Assistant Professor,

Department Of Mechanical Engineering

Christu Jyothi Institute Of Technology & Science, Colombo Nagar, Telangana

**Abstract** Graphene nanoplates, because to their outstanding properties, are finding increasing usage in aerospace engineering. Graphene nanoplates are used in aerospace applications to alleviate problems including lightning strikes, ice accumulation, and other structural impact loads. Adding graphene nanoplates to the wing construction increases its resistance to corrosion. Aircraft wings experience tensile and compressive loads during flight, which may lead to failure before the yield point is reached. In this research, graphene nanoplates are integrated into the wing structure to enhance the structural behaviour of aircraft wings. CATIA is used to simulate the wing's structure, which is made up of composite materials such ribs, spars, and graphene nanoplates. Deformation, stress, strain, and other mechanical data are shown as a consequence of the tests.

## I INTRODUCTION

An aircraft's wings carry the weight of the plane and are intended to lift it into the air. Any specific aircraft's wing configuration is determined by a variety of elements, including size, weight, intended usage, desired speed during takeoff and landing, and desired rate of ascent. The left and right sides of the operator's seat in the cockpit correspond to the left and right wings of an aircraft, respectively.

Often wings are of full cantilever design. This means They are designed to eliminate the requirement for external bracing. Internal structural parts (spars and ribs) and the aircraft's skin help sustain them. Other aircraft wings employ wires or external struts to help with wing support, load carrying, and aerodynamic and landing loads. The majority of wing support cables and struts are constructed of steel. Fairings are commonly found on struts and the attaching fittings

to lessen drag. Jury struts are located on struts that connect to the wings far from the fuselage and are short, almost vertical supports. This helps to reduce oscillation and movement of the strut brought on by airflow around the strut during flight.

Examples of externally braced wings, commonly referred to as semi-cantilever wings, are shown in the image below. Also demonstrated are cantilever wings without any external bracing.

Although wood coated in fabric and occasionally magnesium alloys have been utilised, aluminium is the most popular material for making wings.

In the building of their wings and throughout their airframes, modern aircraft frequently use lighter and stronger materials. There are wings composed of a combination of materials for the best strength to weight performance as well as wings built solely of carbon fibre or other composite materials.

## II LITERATURE STUDIES

Yii-Mei Huang et al [1] focuses on the passive sound management method. Their major goal was to create dynamic dampening absorbers that would reduce vibrations caused by things like propellers and other outside impacts on the fuselage. In order to limit the vibrations and noise produced by the absorbers to a minimum, they analysed the proper parameters to be selected throughout the design phase.

ParthaDey et al [2] comprehends how stable composite skew plates are under stresses. Four-noded shear flexible quadrilateral plates were used to examine the dynamic stability of composite skew plates. The plate's finite element equations were developed. Matrix calculations for elemental mass

and linear-geometric stiffness were performed using the Gaussian integration rule.

Zhiquan LI et al [3], planned to build a full-span model tiltrotor and analyse it using the parameter of aeroelastic stability in flight using past tiltrotor research as a foundation. Additionally, they defined the distinctions between a semi- and full-span model, pinpointed the causes of its instability, and kept track of how surrounding structures affected its aeroelastic stability. They created algorithms to represent different tiltrotor architectures and characteristics after building a theoretical model of the tiltrotor.

**III METHODOLOGY USED**

**Finite Element Analysis (FEA)**

R. Courant created the first version of the finite element analysis (FEA) in 1943. He used the Ritz technique of numerical analysis and variational calculus reduction to find approximations of solutions to vibration systems. A more comprehensive definition of numerical analysis was soon created in a work written by M. J. Turner, R. W. Clough, H. C. Martin, and L. J. Top and published in 1956. The "stiffness and deflection of complex structures" was the main focus of the article.

A computer model of a material or design that has been strained and examined for certain outcomes makes up FEA. Both the creation of new products and the improvement of already existing products employ it. Prior to production or construction, a corporation can confirm a suggested design would be able to meet the client's requirements. An current product or structure can be modified to meet the requirements of a new service condition. FEA may be employed to assist in deciding how to modify the design in the event of structural failure.

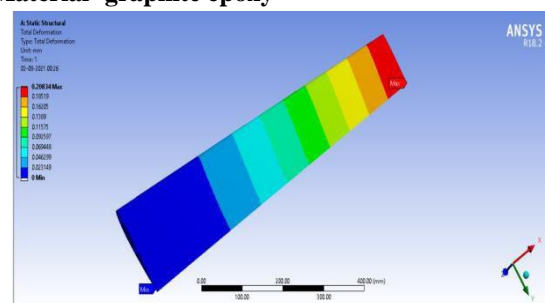
The two main forms of analysis utilised in business are 2-D modelling and 3-D modelling. Even though 2-D modelling keeps things simple and enables the analysis to be conducted on a reasonably standard computer, it typically produces less precise findings. However, 3-D modelling yields more precise findings at the expense of being ineffective on all but the fastest processors. Programmers can add a variety of

algorithms (functions) to any of these modelling frameworks to influence the system's linear or nonlinear behaviour. In general, linear systems are far less complicated and do not account for plastic deformation. Plastic deformation is taken into consideration by non-linear systems, and several of them can test materials all the way to fracture.

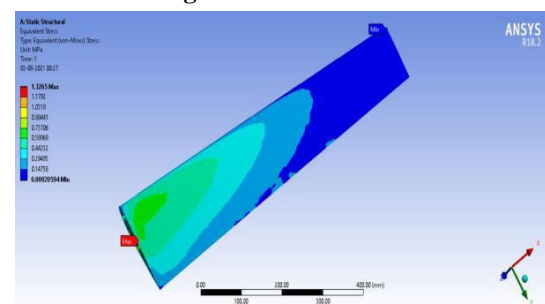
A mesh is a grid made up of a complicated network of nodes, or points, that are used in FEA. The material and structural qualities that determine how the construction will respond to different loading circumstances are encoded into this mesh. Depending on the expected amounts of stress in a specific place, nodes are distributed throughout the material at a certain density. A higher node density is typically found in areas that will encounter more stress than those that would receive little to no load. The fracture point of previously tested material, fillets, corners, intricate details, and high stress zones are possible points of interest. Because a mesh element extends from each node to each of the surrounding nodes, the mesh behaves like a spider web.

**IV STATIC ANALYSIS OF AIRCRAFT WING WITH RIBS AND SPARS**  
**CASE 1: ANALYSIS OF AIRCRAFT WING WITHOUT GRAPHENE COATING**

Material- graphite epoxy

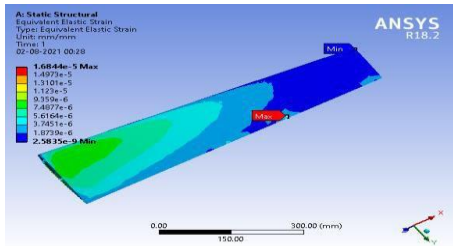


**Fig 1: Deformation**



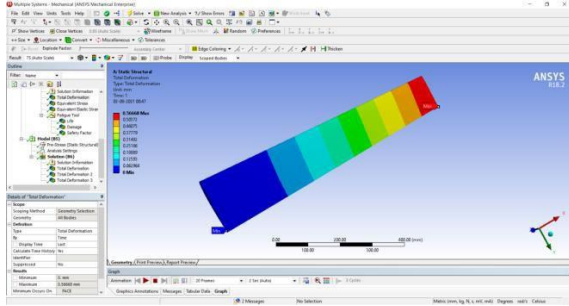
**Fig 2: Stress**

**MATERIAL- KEVLAR EPOXY**

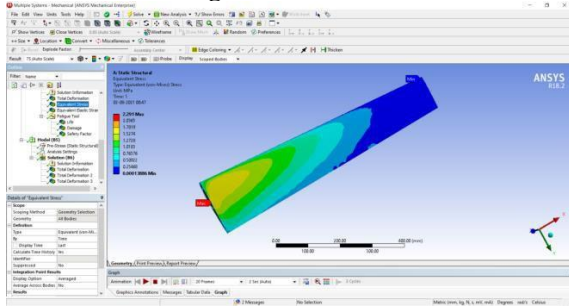


**Fig 3: Strain**

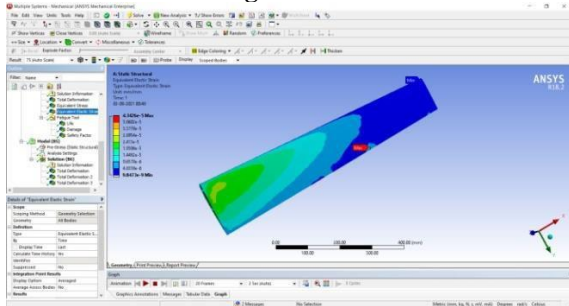
**MATERIAL- KEVLAR EPOXY**



**Fig 4: Deformation**

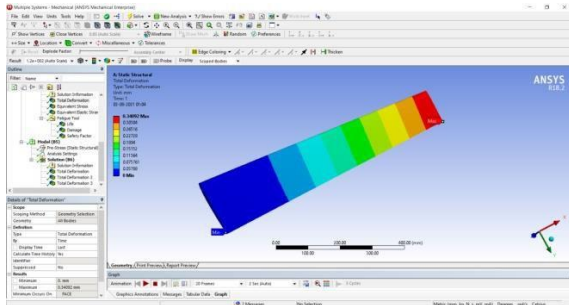


**Fig 5: Stress**

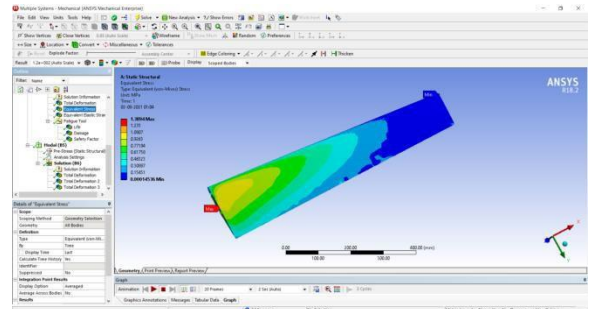


**Fig 6: Strain**

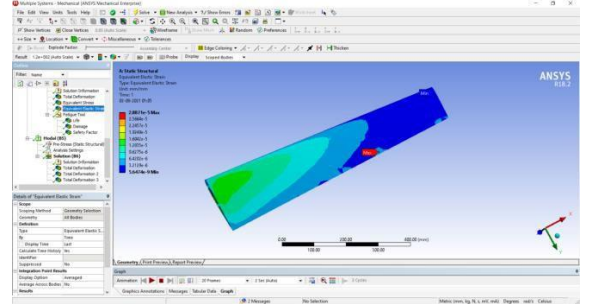
**MATERIAL- GLASS FIBER**



**Fig 7: Deformation**

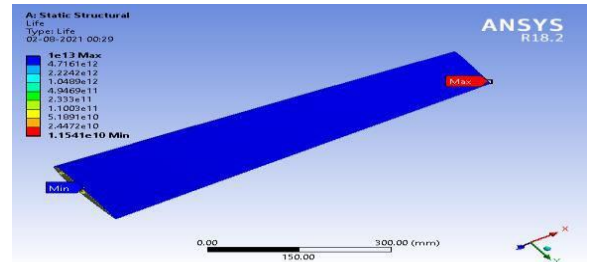


**Fig 8: Stress**

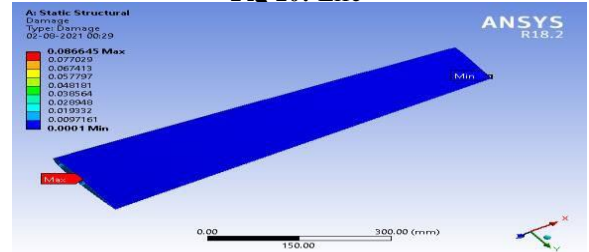


**Fig 9: Strain**

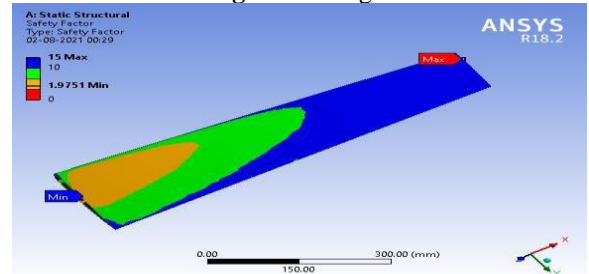
**FATIGUE ANALYSIS OF AIRCRAFT WING WITH RIBS AND SPARS MATERIAL- GRAPHITE EPOXY**



**Fig 10: Life**

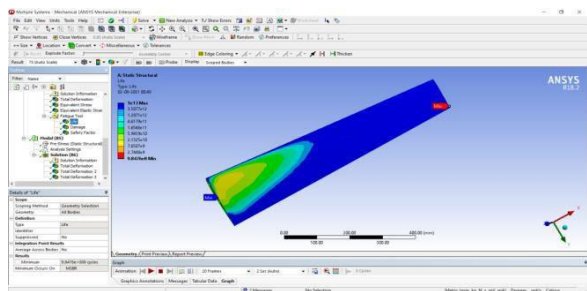


**Fig 11: Damage**

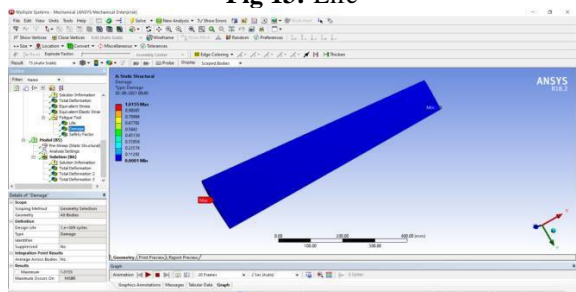


**Fig 12: Safety factor**

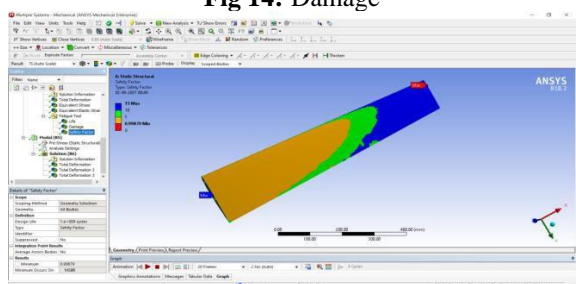
**MATERIAL- KEVLAR EPOXY**



**Fig 13: Life**

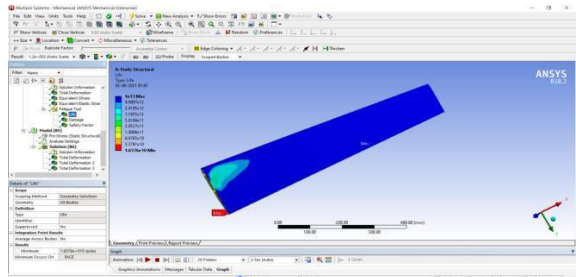


**Fig 14: Damage**

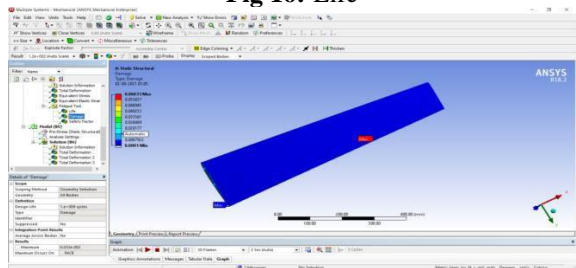


**Fig 15: Safety factor**

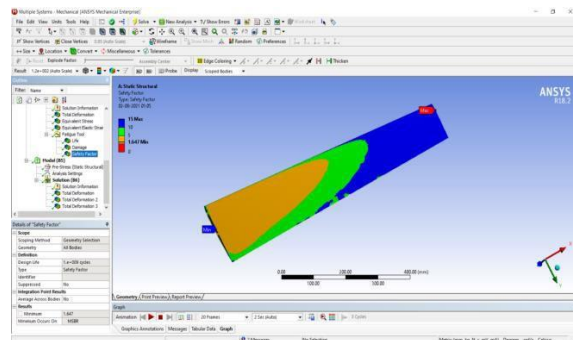
**MATERIAL- GLASS FIBER**



**Fig 16: Life**

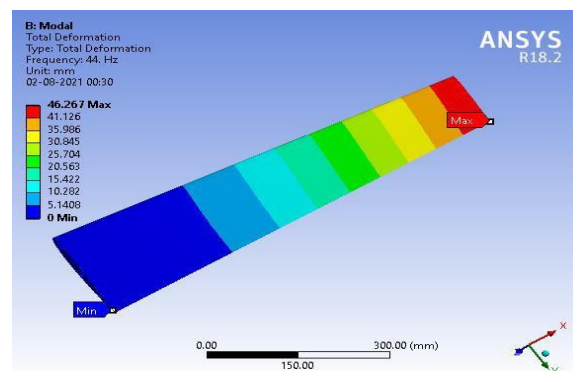


**Fig 17: Damage**

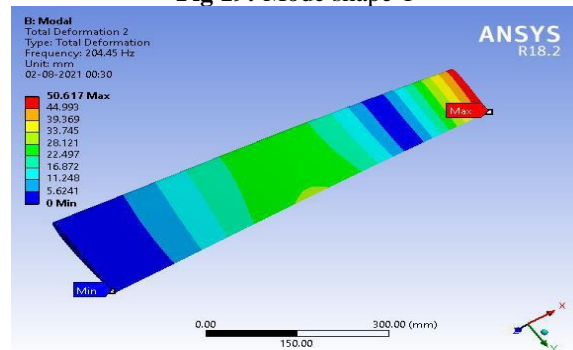


**Fig 18: Safety factor**

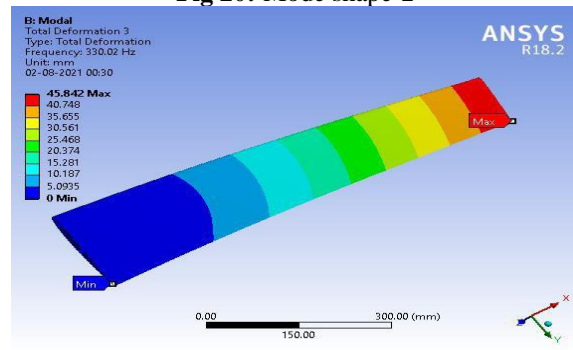
**MODAL ANALYSIS OF AIRCRAFT WING WITH RIBS AND SPARS MATERIAL- GRAPHITE EPOXY**



**Fig 19: Mode shape-1**



**Fig 20: Mode shape-2**



**Fig 21: Mode shape-3**

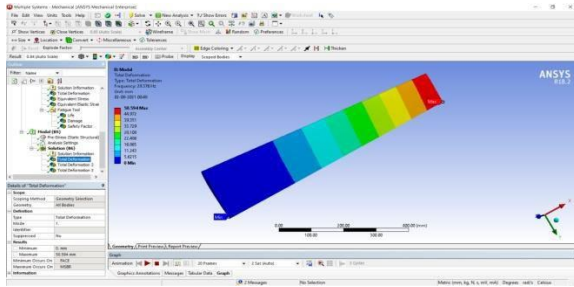


Fig 22: Mode shape 1

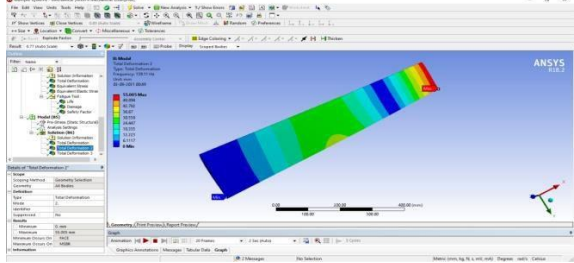


Fig 23: Mode shape 2

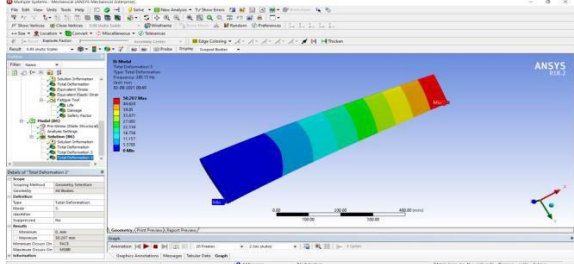


Fig 24: Mode shape 3

**MATERIAL- GLASS FIBER**

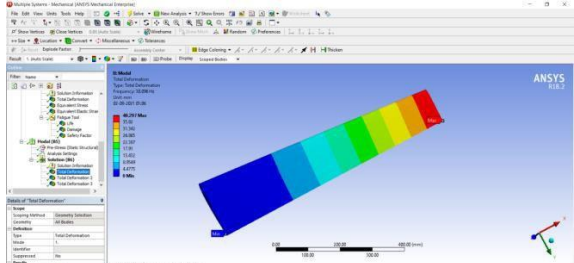


Fig 25: Mode shape 1

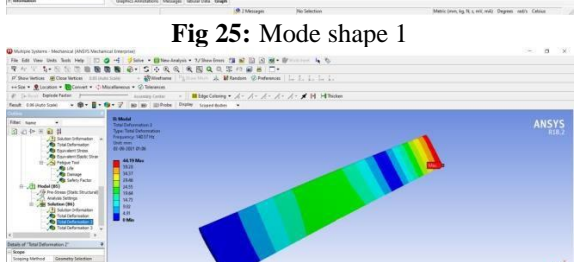


Fig 26: Mode shape 2

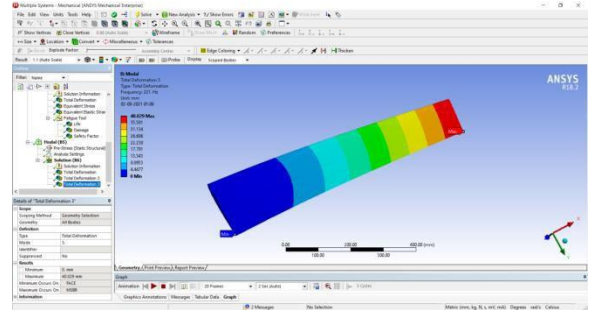


Fig 27: Mode shape 3

**ANALYSIS OF AIRCRAFT WING WITH GRAPHENE COATING**  
**STATIC ANALYSIS OF AIRCRAFT WING WITH RIBS AND SPARS**

**MATERIAL- GRAPHITE EPOXY**

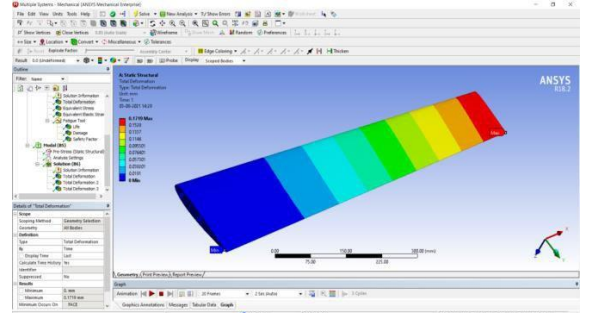


Fig 28: Deformation

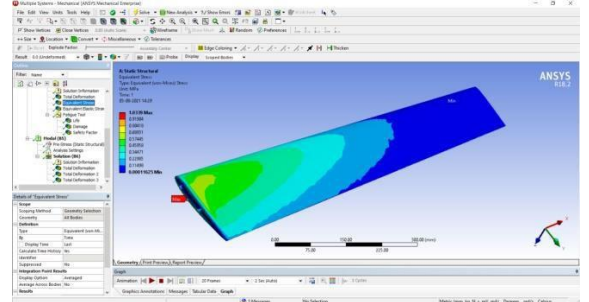


Fig 29: Stress

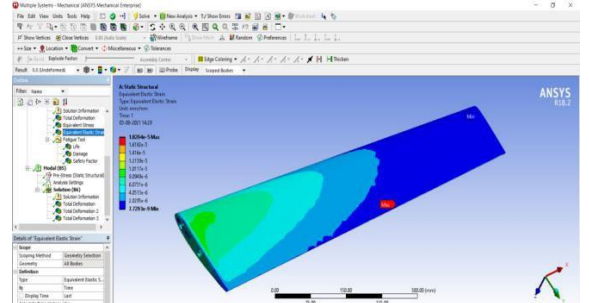


Fig 30: Strain

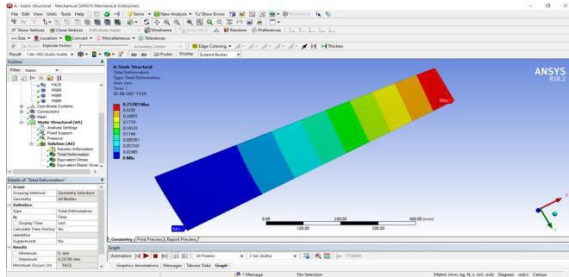


Fig 31: Deformation

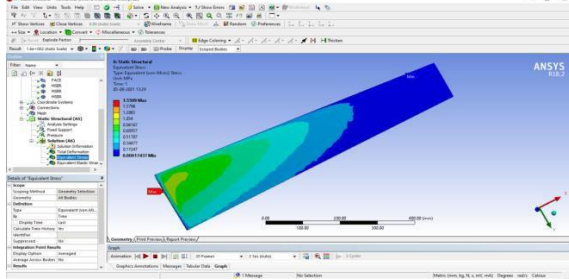


Fig 32: Stress

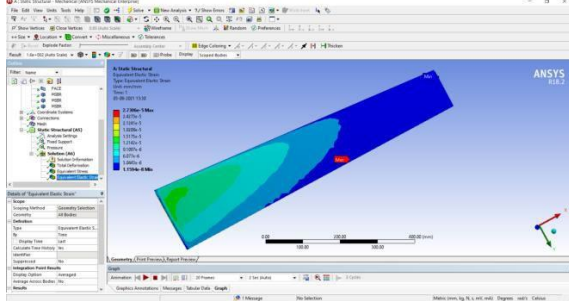


Fig 33: Strain

**MATERIAL- GLASS FIBER**

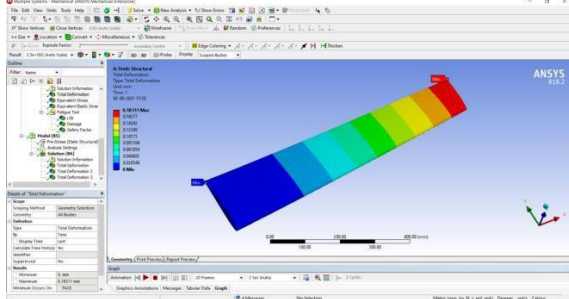


Fig 34: Deformation

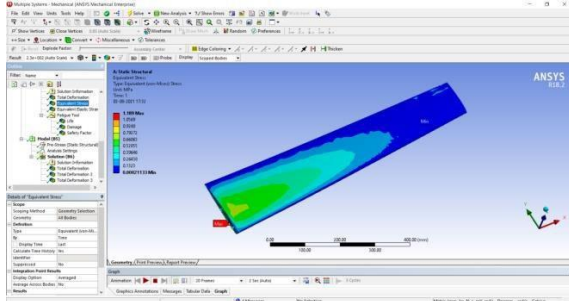


Fig 35: Stress

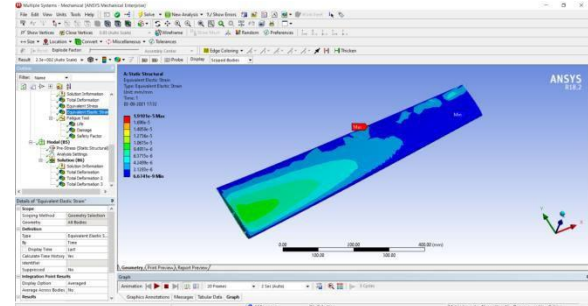


Fig 36: Strain

**Material- aluminium alloy**

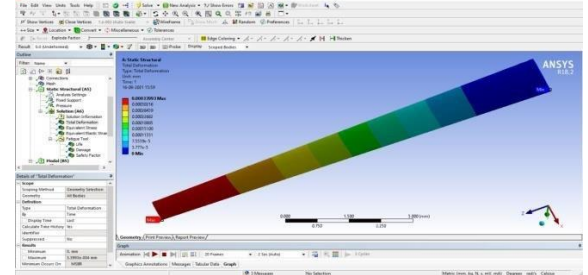


Fig 37: Deformation

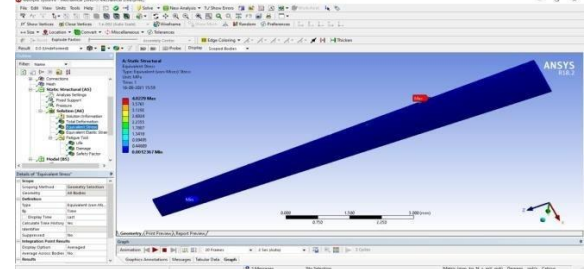


Fig 38: Stress

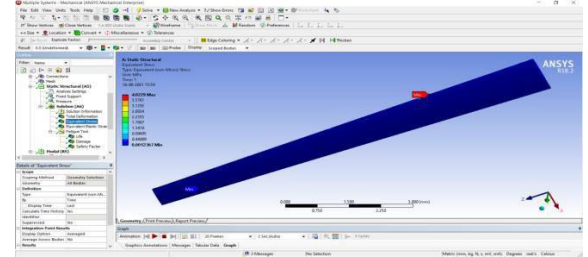


Fig 39: Strain

**FATIGUE ANALYSIS OF AIRCRAFT WING WITH RIBS AND SPARS MATERIAL- GRAPHITE EPOXY**

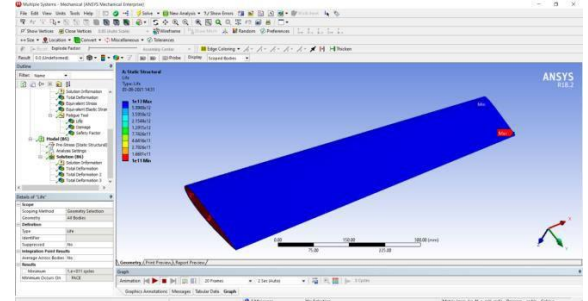


Fig 40: Life

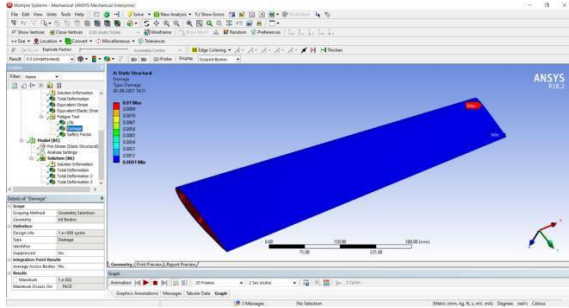


Fig 41: Damage

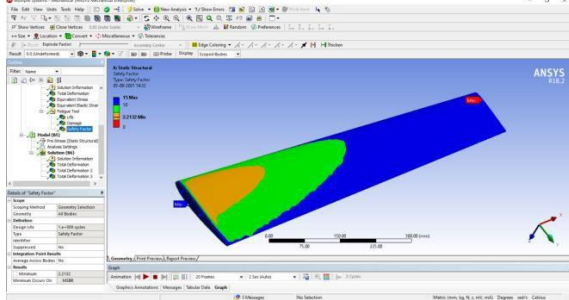


Fig 42: Safety factor

**MATERIAL- KEVLAR EPOXY**

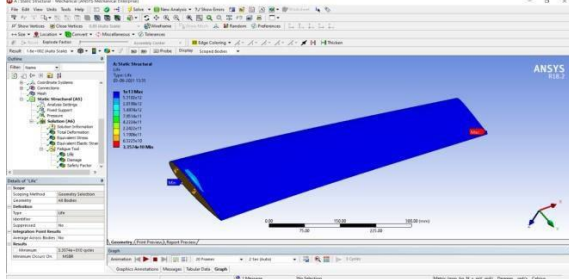


Fig 43: Life

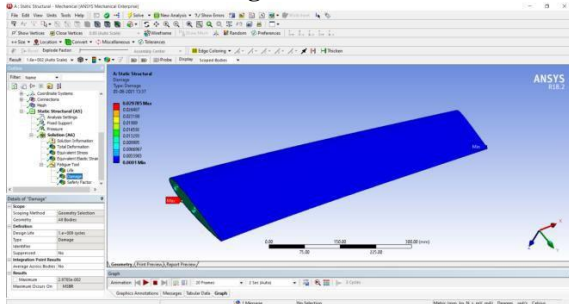


Fig 44: Damage

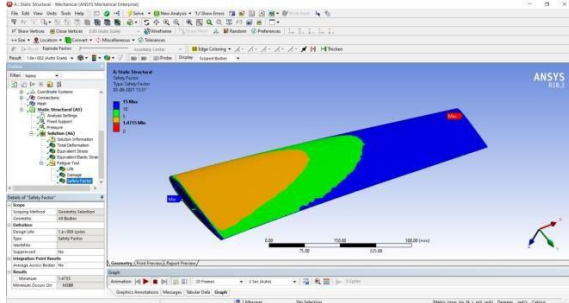


Fig 45: Safety factor

**MATERIAL- GLASS FIBER**

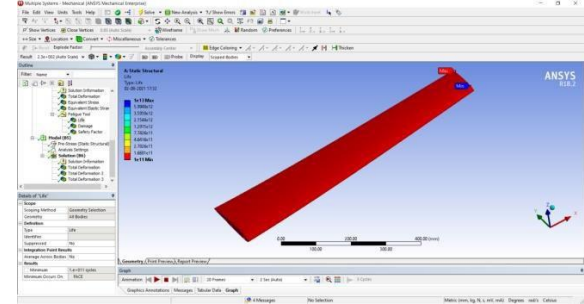


Fig 46: Life

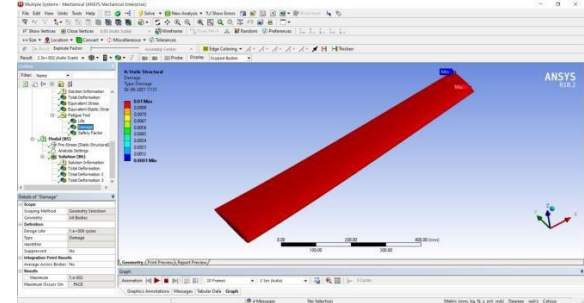


Fig 47: Damage

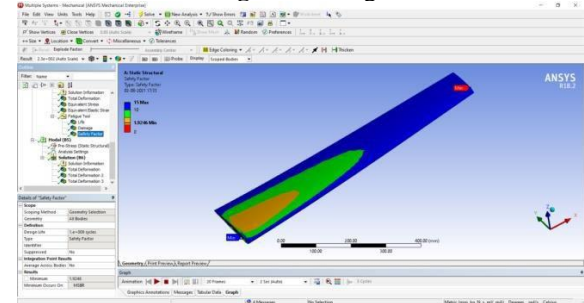


Fig 48: Safety factor

**Material – aluminium alloy**

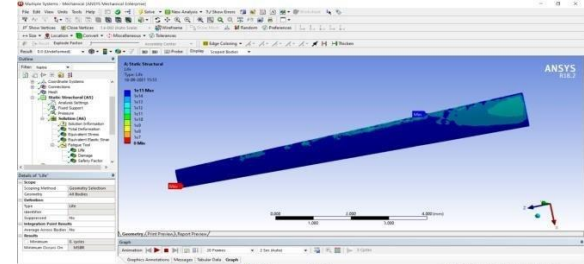


Fig 49: Life

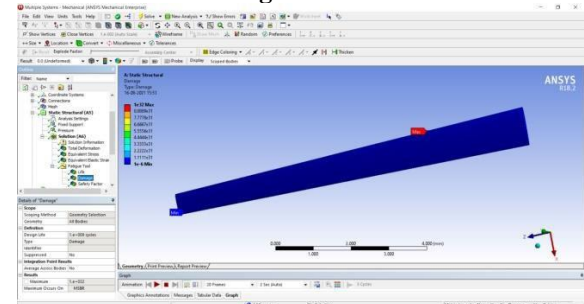
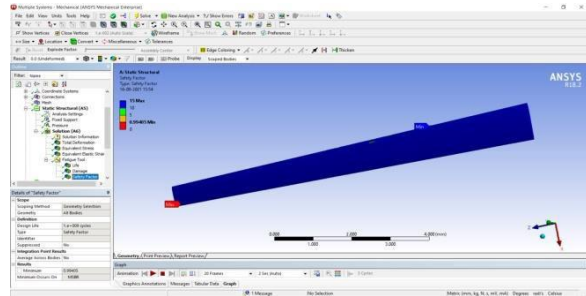
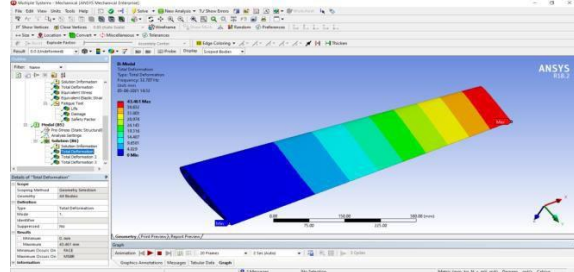


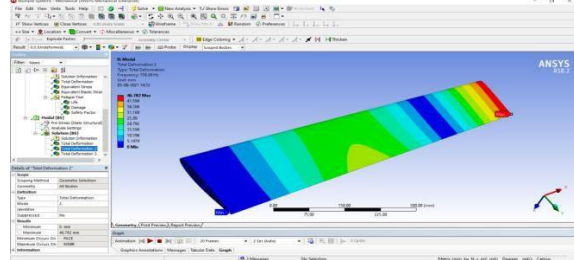
Fig 50: Damage



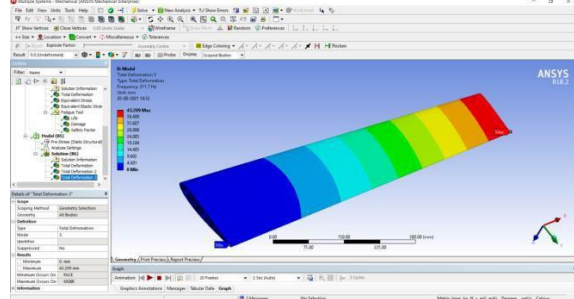
**Fig 51: Safety factor  
MODAL ANALYSIS OF AIRCRAFT WING  
WITH RIBS AND SPARS  
MATERIAL- GRAPHITE EPOXY**



**Fig 52: Mode shape 1**

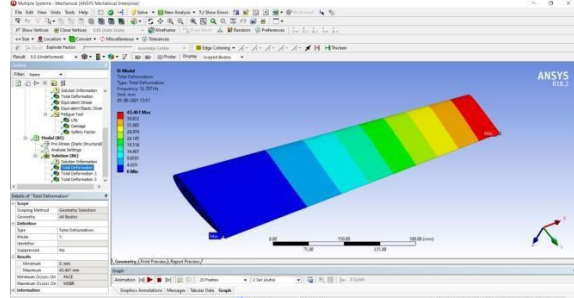


**Fig 53: Mode shape 2**

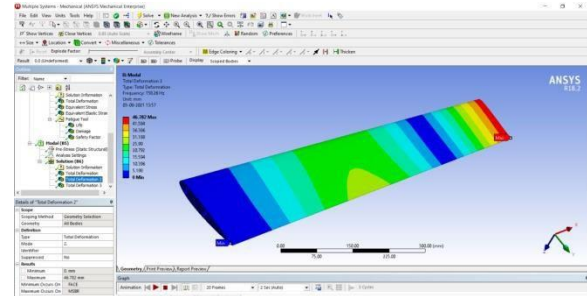


**Fig 54: Mode shape 3**

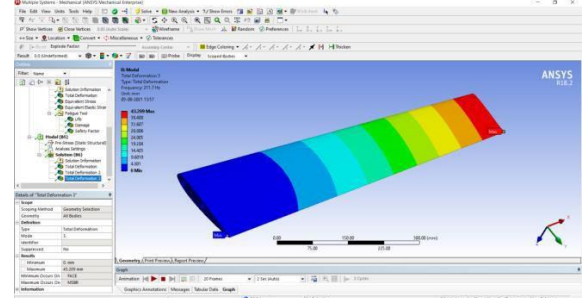
**MATERIAL- KEVLAR EPOXY**



**Fig 55: Mode shape 1**

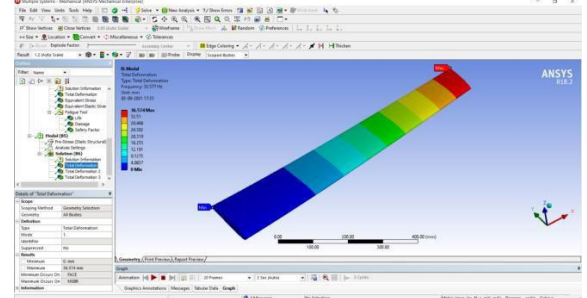


**Fig 56: Mode shape 2**

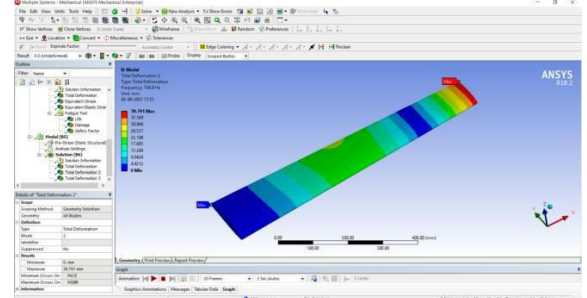


**Fig 57: Mode shape 3**

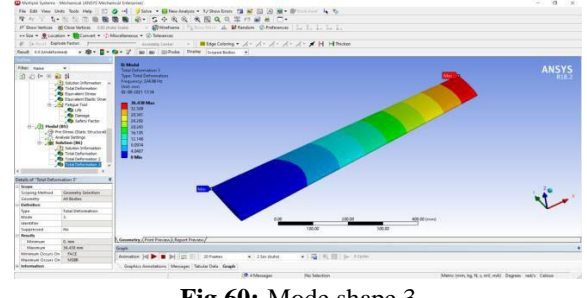
**MATERIAL- GLASS FIBER**



**Fig 58: Mode shape 1**



**Fig 59: Mode shape 2**

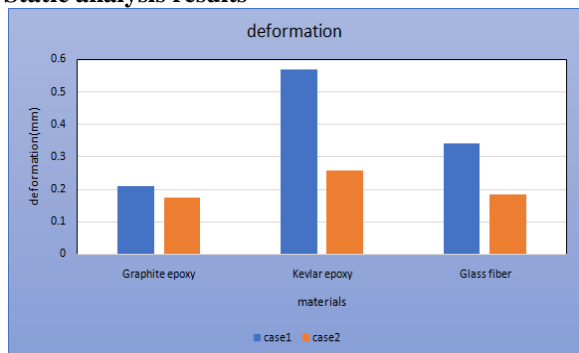


**Fig 60: Mode shape 3**

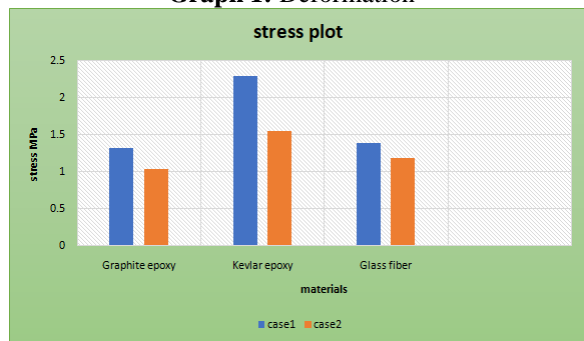


V RESULTS AND DISCUSSIONS

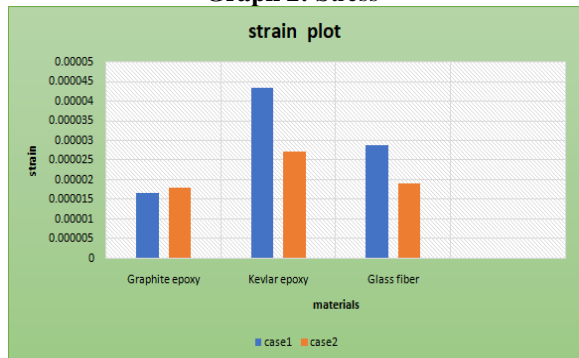
Static analysis results



Graph 1: Deformation



Graph 2: Stress



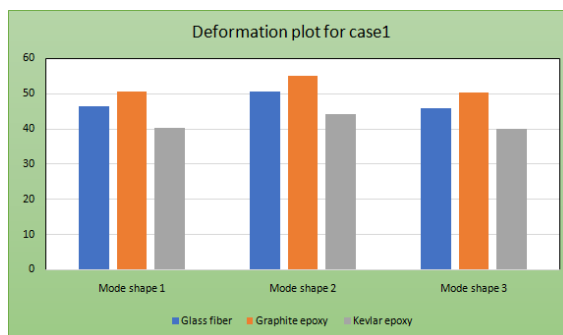
Graph 3: Strain

Fatigue analysis results

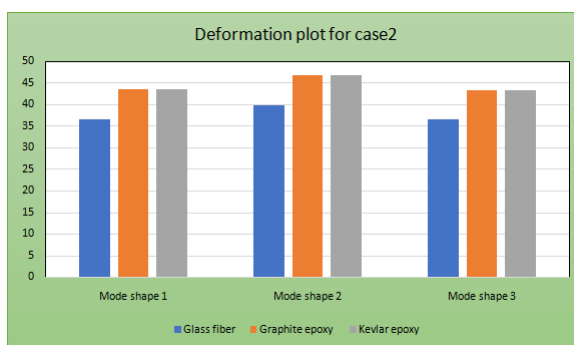


Graph 4: Safety factor

Modal analysis results



Graph 5: Deformation case 1



Graph 6: Deformation case 2

VI CONCLUSIONS

The trainer aircraft wing structure with skin, spars, and ribs is taken into consideration for the full analysis in this work. Two skinned spars and 15 ribs make up the wing structure. The skin is made of an aluminium alloy and has a graphene coating. Both the front and the rear spars have "C" sections. To calculate the stresses and life at spars and ribs owing to the applied pressure load, a stress and fatigue study of the entire wing section is performed.

Results from this experiment were compared to those of wings made of aluminium alloy and wings covered with graphene.

Materials including glass fibre, graphite epoxy, and Kevlar epoxy were taken and placed to the ribs and spars. The wing skin is made of coated graphene and aluminium alloy.

When compared to models and glass fibre and kevlar epoxy, the graphite epoxy material has less stress, according to static study of aircraft wings. Less stress is present in wings made of aluminium alloy and covered in graphene.

The deformation, stress, and strain values for the aluminium alloy material at hand were compared to those for composite materials.

When compared to composite materials, the current material has higher stress values.

By looking at the modal analysis of an aircraft wing, one can see that the deformation and frequency values are higher for the material Graphite epoxy. According to the fatigue study of an aircraft wing, graphite epoxy material has a higher safety factor value.

The conclusion is that the graphite epoxy material and the wings with aluminium alloy and graphene coating are superior materials for aeroplane wings.

## REFERENCES

- [1] Yii-Mei Huang, Chun-Cheng Chen, Optimal design of dynamic absorbers on vibration and noise control of the fuselage, *Computers & Structures*, Volume 76, Issue 6, Pages 691-702.
- [2] ParthaDey, M.K. Singha, Dynamic Stability Analysis Of Composite Skew Plates Subjected To Periodic In-Plane Load, *Thin-Walled Structures*, Volume 44, Pages 937–942 .
- [3] Zhiquan Li, Pinqi Xia, Aeroelastic stability of full-span tiltrotor aircraft model in forward flight, *Chinese Journal of Aeronautics*, Volume 30, Issue 6, Pages 1885-1894 .
- [4] Jesus Garicano-Mena, Estaban Ferrer, Silvia Sanvido, Eusebio Valero, A stability analysis of the compressible boundary layer flow over indented surfaces, *Computers and Fluids*, Volume 160, Pages 14-25 .
- [5] Liang QU, Yinghui LI, Haojun XU, Dengcheng ZHANG, Guoqiang YUAN, Aircraft Nonlinear Stability Analysis And Multidimensional Stability Region Estimation Under Icing Conditions, *Chinese Journal of Aeronautics*, Volume 30, Issue 3, Pages 976–982 .
- [6] Wencheng Li, DongpingJin, Flutter suppression and stability analysis for a variable-span wing via morphing technology, *Journal of Sound and Vibration*, Volume 412, Pages 410-423.
- [7] N. Siepenkötter, W. Alles, Stability Analysis Of The Nonlinear Dynamics Of Flexible Aircraft, *Aerospace Science and Technology*, Volume 9, Pages 135–141.
- [8] C. Natale, G. Aurilio, G. De Maria, Modal Analysis And Vibration Control Of A Fuselage Aeronautical Panel, *IFAC Proceedings Volumes*, Volume 35, Issue 2, Pages 117-122.
- [9] Robert M. Hall, Impact of Fuselage Cross Section On The Stability Of A Generic Fighter, *NASA Langley Research Center*, AIAA-98-2725.
- [10] Wen Jing, Wang Yankui, Deng Xueying, An Experimental Investigation On Static Directional Stability, *Chinese Journal of Aeronautics*, Volume 29, Issue 6, Pages 1527– 1540.
- [11] T.P. Ratvasky and R.J. Ranaudo, Icing Effects on Aircraft Stability and Control Determined from Flight Data, *31st Aerospace Sciences Meeting and Exhibit*.
- [12] Fabrizio Nicolosi, Agostino De Marco, Pierluigi Della Vecchia, Stability, Flying Qualities And Longitudinal Parameter Estimation Of A Twin-Engine CS-23 Certified Light Aircraft, *Aerospace Science and Technology*, Volume 24, Pages 226–240.
- [13] FabrizioNicolosi, Salvatore Corcione, Pierluigi Della Vecchia, Commuter Aircraft Aerodynamic Design: Wind-Tunnel Tests And CFD Analysis, *29th International Congress Of The Aeronautical Sciences*.
- [14] MasoudMirzaei, Mohammad HadiKarimi a, Mohammad Ali Vaziri, An Investigation of A Tactical Cargo Aircraft Aft Body Drag Reduction Based On CFD Analysis And Wind Tunnel Tests, *Aerospace Science and Technology*, Volume 23, Pages 263–269.