

EXPERIMENTAL INVESTIGATION OF HYBRID EPOXY COMPOSITES INCORPORATING COCONUT FIBER, BAMBOO FIBER, AND PLASTIC PARTICULATES

¹TALLOORI SAI KUMAR, ²BYRI DIMPLE, ³YANAKAPATI KRISHNA, ⁴V. HARSHA VARDHAN
^{1,2,3}Assistant Professor, ⁴Student

*Department Of Mechanical Engineering
Abdul Kalam Institute of Technological Sciences, Kothagudem, Telangana*

ABSTRACT

Despite being one of the materials utilized the most in the world today, plastic's manufacture and disposal have a significant negative impact on the environment and landfill space. Recycling allows for the material to be recovered from used plastic and then used to create new plastic products like particle boards, plastic lumber, and containers. Prior to this, the waste plastic will be shred into small bits so that it may be shipped and ready for additional processing. In the end, the vast quantities of these different kinds of plastic that are currently being marketed will wind up in landfills or other waste disposal sites. Because of this, waste products are causing problems because of the amount of garbage they produce, their inability to biodegrade, and the fact that their short life cycle causes the fastest depletion of natural resources. As a result, both the quantity of garbage produced and the quantity of materials needed to create it have increased. We are turning our research into a model for recycling plastic waste in residential, commercial, and other settings. There is an abundance of plastic waste in this specific area. The act of gathering, classifying, processing, and reusing used plastic materials that would otherwise be disposed of as solid waste is known as plastic recycling, sometimes referred to as reprocessing. These materials would end up as landfill waste if they weren't recycled. A waste plastic shredder is a machine that can shred used plastic bottles into tiny particles. This enhances the bottle's portability, usability, and suitability for blending into another brand-new product. We can determine that plastic is shredded with the use of a plastic shedding machine; thus, we also design and manufacture plastic shredder machines.

Some of the crucial terms in this context are plastic shredders, hybrid composites, epoxy, and mechanical characteristics.

1. INTRODUCTION:

1. Plastic Shredder Machine

1.1 shredder machine

Plastic is one of the most common used materials in the world today, but, they cause serious environmental pollution and exhaustion of landfill space. The recycling of waste plastic recovers the material, which can be used to make new plastic products such as containers, plastic lumbers and particle boards. For this to happen, the waste plastic will first be shred into small bits making it ready for transportation and further processing. The shredder has the feeding unit, the shredding unit, power transmission unit and the machine frame.

The performance of the machine was evaluated and test results showed that there was a correlation between the machine speed with a regression less than 1 and there was a linear relationship with all variable parameters (the shredding time (t), the specific mechanical energy (sme), throughput (tp) and recovery efficiency (re)) and the variable operation speeds. The throughput of the machine is 27.3 kg/hr and the efficiency is 53% for all type of plastic and 95% for polyvinylchloride type of plastic. The machine is user friendly and the cost of producing one unit of the machine as at the time of fabrication was estimated to only making it affordable to acquire for small and medium scale entrepreneurs in waste plastic recycling business

Plastic have become an essential part of our day to day life since their introduction over hundred years ago. It is one of the most commonly used materials in

the world today. They come in five major categories; the polyethylene terephthalate (pet), the high density polyethylene (hdpe), the polyvinylchloride (pvc), the polypropylene (pp) and the low density polyethylene (ldpe). The huge quantities of these plastic categories currently being marketed will ultimately find their way to the waste dump sites. This is creating waste products problems due to its high amount of waste generated, non-biodegradability and the fastest depletion of natural resources regarding its short life cycle, therefore increased amount of material utilized in its production, and waste generated.

plastic bottles make up approximately 11% of the content landfills, causing serious environmental consequences. The plastic waste globally constitutes more than 60% of the total global municipal solid waste (msw), 22% were recovered and 78% disposed. In united states, the waste of plastics in 2005 was calculated as 11.8% of the 246 million tons of msw generated. Some states in the us like michigan have a recycling rate that is close to 100% and in brazil, some potential in recycling have been raised where around 15% of all plastics consumed are recycled and returned to industry. Locally in nigeria and for nigerian cities and towns, different researches have been carried out on the challenges of solid wastes in nigeria. India and africa generally, but works on plastic wastes in nigerian cities and towns are still limited. Developing countries like nigeria have to import virgin plastic at high cost because recycling activities are usually low in these countries.

Machinery available for recycling activities in these countries are usually of very high cost and bulky and as such, recycling activities are restricted by these challenges in these countries. Therefore, to overcome these challenges, it was necessary to develop a low cost waste plastic shredding machine using available local materials that can easily be operated without much skill for low and medium income earner. This will prepare the recycled plastic for the production of new products in nigeria. Plastic recycling or reprocessing is usually referred to as the process by which plastic waste material that would otherwise become solid waste are collected, separated, processed and returned to use.

Waste plastic shredder is a machine that reduces used plastic bottles to smaller particle sizes to enhance its portability, easiness and readiness for use into another new product. The design principle of this machine was got from the ancient tradition method of using scissors to cut materials into reduced form and scratching used by rabbits when digging or tearing. These two traditional methods were applied in the design of the machine by fabricating cutting blades to cut the waste plastic while some of the cutting blades have sharp curved edges to draw-in the plastic into the cutting blades teeth. The waste plastic shredder comprises of four major components, namely; the feeding unit, the shredding unit, the power unit and the machine frame. The machine can be powered by electric motor of 10 hp.

1.2 machine description and operation:

The waste plastic shredder has four main components; the feeding unit, the shredding unit, the power unit and the machine frame. The feeding unit is made of 16 – gauge mild steel sheet of 9 mm thick plate and a dimension of 200 mm × 550 mm through which the waste plastic are fed into the shredding unit. The shredding unit is where the waste plastic are been cut into smaller sizes. The unit consists of a shaft, 50 mm length made up of 30 mm mild steel rod and a cylinder of 55 mm length and 200 mm diameter. Attached to the shaft are cutters made of 12 mm mild steel having nine serrated teeth welded 2 mm apart. The cylinder equally has same cutters with sharp edges to shred the waste plastic. Underneath the shredding unit is the outlet made of 16-gauge mild steel. The shredded waste plastic discharge freely from the shredding unit through the outlet. The machine is powered by 10 hp electric motor with the aid of belt and pulley arrangement which has 110 mm diameter driven pulley and 60 mm driver pulley

1.3 design consideration:

Some of the factors considered in the design of the recycled plastic waste shredding machine are safety, power requirement, compactness, ease of operations and overall cost of production. Material selection

based on availability, durability, cost and ease of fabrication were also considered.

Machine components:

Volume of the hopper = area of cross-section of the hopper \times width of hopper = $\frac{1}{2} (a + b) h \times \text{width} \dots$

Volume of pet bottle (coca cola) in the shredding chamber:

No of bottle to fill the hopper = volume of hopper / volume of pet bottle

Volume of pet bottle (coca-cola bottle) =

$$\text{Area} \times \text{height} = \frac{\pi d^2}{4} \times h \dots (2)$$

Determination of shaft diameter

$$d^3 = \frac{16}{\pi \tau} \sqrt{(k_b m_b)^2 + (k_t m_t)^2} \dots (3)$$

al.

Where,

D = diameter of the shaft = 30 mm

τ = allowable shear stress of metal with key way = $40 \times 106 \text{ n/m}^2$

M_b = maximum bending moment = 25.61 nm

M_t = torsion moment = 22.3 n

K_b = combined shock and fatigue factor applied to bending moment = 2.0 (sudden loading)

K_t = combined shock and fatigue factor applied to tensional moment = 2.0 (sudden loading)

1.4 performance evaluation procedure:

One kilogram (1 kg) each of the four different plastic types (polyethylene terephthalate (pet), the high density polyethylene (hdpe), the polyvinylchloride (pvc) and the polypropylene (pp) were shredded at varied motor speed using 10 hp three-phase electric motor as the prime mover.

The shredded waste plastic, q, was weighed to determine the quantity of the actual shredded waste plastic before sieving into three different sizes in order to determine their average size and area using excel 2014. The shredding time (t), the specific mechanical energy (sme), throughput (tp) and recovery efficiency (re) of the machine were also determined using the relationship below:

Specific mechanical energy = power (p) \times time (t)

Output mass (q)

Throughput (tp) = output mass of recycled waste plastic (q)

Time taken for recycling (t)

Recycling efficiency (re) = output mass of recycled waste plastic (q) \times 100

2. Introduction of composites

2.1 composites:

The ideas of composites materials is not a new or recent one. Nature is full of examples where in the idea of composite materials is used. The coconut palm leaf, for example, is nothing but a cantilever using the concept of fiber reinforcement. Wood is a fibrous composite: cellulose fibers' in a lignin matrix. The cellulose fibers have high tensile strength but are very flexible (i.e. Low stiffness), while the lignin matrix joins the fibres' and furnishes the stiffness. Bone is yet another example of a natural composites that supports the weight of various members of the body. It consists of short and short collagen fibers embed in a mineral matrix called apatite. In addition to these naturally occurring composites, there are many other engineering materials that are composites in a very general way and that have been in use for

very long time. The carbon black in rubber, portland cement or asphalt mixed with sand, and glass fibers in resin are common examples. Thus, we see that the idea of composite materials is not that recent. Nevertheless, one can safely mark the origin of the distinct discipline of the composites materials as the beginning of the 1960s. It would not be too much off mark to say that a concerted research and development effort in composite materials began in 1965. Since the early 1960s, there has been an increasing demand for materials that are stiffer and stronger yet lighter in fields as diverse as aerospace, energy and civil constructions. The demands made on materials for better overall performance are so great and diverse that no one material can satisfy them. This naturally led to a resurgence of the ancient concept of combining different materials in an integral-composite material to satisfy the user requirement. Such composites material system results in a performance unattainable by the individual constituents, and they offer the great advantage of a flexible design; that is, one can, in principle tailor make the material as per specifications of optimum design.

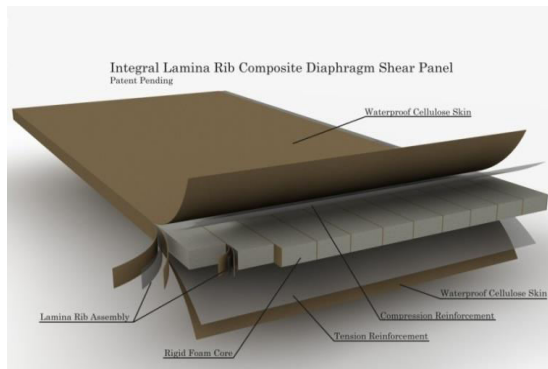

fig: hybrid epoxy composite

2.2 preparation methods:

Hand lay-up technique:

Hand lay-up technique is the simplest method of composite processing. The infrastructural requirement for this method is also minimal. The processing steps are quite simple. First of all, a release gel is sprayed on the mold surface to avoid the sticking of polymer to the surface. Thin plastic sheets are used at the top and bottom of the mold

plate to get good surface finish of the product. Reinforcement in the form of woven mats or chopped strand mats are cut as per the mold size and placed at the surface of mold after perspex sheet. Then thermosetting polymer in liquid form is mixed thoroughly in suitable proportion with a prescribed hardener (curing agent) and poured onto the surface of mat already placed in the mold. The polymer is uniformly spread with the help of brush. Second layer of mat is then placed on the polymer surface and a roller is moved with a mild pressure on the mat-polymer layer to remove any air trapped as well as the excess polymer present. The process is repeated for each layer of polymer and mat, till the required layers are stacked. After placing the plastic sheet, release gel is sprayed on the inner surface of the top mold plate which is then kept on the stacked layers and the pressure is applied. After curing either at room temperature or at some specific temperature, mold is opened and the developed composite part is taken out and further processed. The schematic of hand lay-up is shown in figure 1. The time of curing depends on type of polymer used for composite processing. For example, for epoxy based system, normal curing time at room temperature is 24-48 hours. This method is mainly suitable for thermosetting polymer based composites. Capital and infrastructural requirement is less as compared to other methods. Production rate is less and high volume fraction of reinforcement is difficult to achieve in the processed composites. Hand lay-up method finds application in many areas like aircraft components, automotive parts, boat hulls, dias board, deck etc. Generally, the materials used to develop composites through hand lay-up method

Hand Lay-Up Manual Process

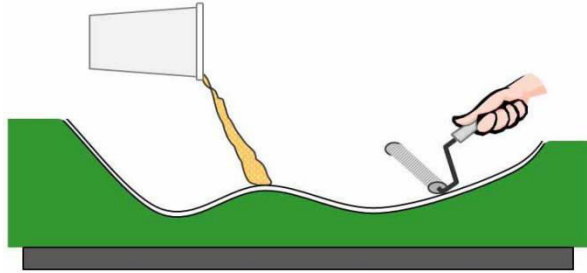

Fig: handmade lay-up process

3. Epoxy resin

Epoxy resins are formed from a long chain molecular structure similar to vinylester with reactive sites at either end. In the epoxy resin, however, they these reactive sites are formed by epoxy groups instead of ester groups, the absence of ester groups means that the epoxy resin has particularly good water resistance. The epoxy molecule also contains two ring groups and at its center which are able to absorb both mechanical and thermal stresses better than linear groups and therefore give the epoxy resin very good stiffness, toughness and heat resistant properties.

Epoxies differ from polyester resin in that are cured by a hardener rather than a catalyst. The hardener , often an amine, is used to cured the epoxy by an addition reaction where both materials take place in the chemaical reaction.

density	1.35 g/cc
young's modulus	3200 mpa
poisson's ratio	0.35

design of plastic shredder blade:

Properties and specifications of plastic shredder blade:

- Type of material = en31 material
- Diameter of blade = 80 mm
- Thickness of blade = 10 mm
- Height of blade = 120 mm
- Thermal conductivity = 46 w/m k
- Chemical composition = c (0.25—29%),cu (0.20%), fe (98%), m n (1.03%)
- Melting point = 2570 degree fahrenheit
- Impact strength = 31 j
- Ultimate tensile strength = 841 m pa
- Specific gravity = 7.75 – 8.05 gm/cm3

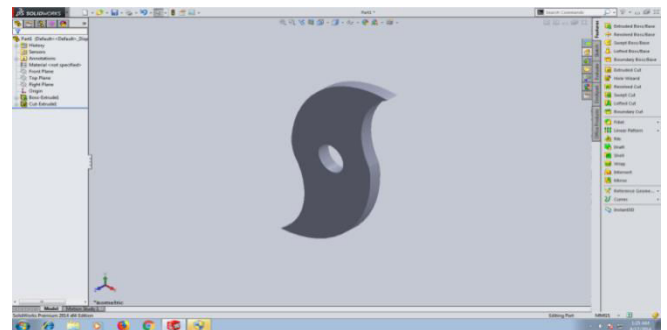

Fig: plastic shredder machine cutting blade

Design of plastic shredder box (mechanism holding head box):

Properties and specifications of plastic shredder box (mechanism holding head box):

- Type of material = mild steel
- Diameter of hole = 25 mm
- Thickness of box = 10 mm
- Width of box = 200 mm
- Length of box = 380mm
- Impact strength = 31 j
- Ultimate tensile strength = 290 m pa

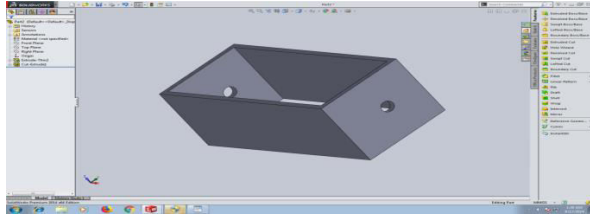

Fig: design of plastic shredder box (mechanism holding head box):

design of pulley:

Specifications and properties of pulley:

- Type of material = aluminum
- Diameter of pulley = 50 mm (inside diameter)
- Ultimate tensile strength = 290 m pa
- Specific heat = 0.900 j/ gm k

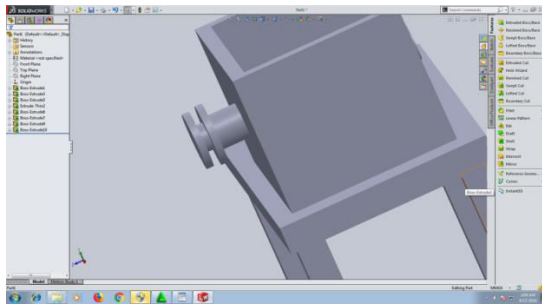

Fig: pulley

Design of electrical motor

Specifications of electrical motor:

- Speed = 1440 rpm
- Single phase motor
- Power = 230v

- Foot mounted
- Psc = 2.5amps
- 90s frame
- Aluminum body
- Model = 710
- Sakthi industries,coimbatore

specification of resins and hardner:

Type of material	Property	Specification	Units
Araldite ly 556 resin	Viscosity (at 25 degree centigrade)	10000 - 12000	M pa. S
Araldite ly 556 resin	Density (at 25 degree centigrade)	1.15-1.20	Gm/cc
Araldite ly 556 resin	Flash point	>200	C
Aradur hy 951 hardener	Viscosity (at 25 degree centigrade)	10-20	M pa. S
Aradur hy 951 hardener	Density (at 25 degree centigrade)	0.97-0.99	Gm/cc
Aradur hy 951 hardener	Flash point	>180	C

WEIGHT FRACTION OF THE FIBER:

The weight of the matrix was calculated by multiplying density of the matrix and the volume. Corresponding to the weight of the matrix the specified weight percentage of fibers is taken. For hybrid combination weight of fiber obtained is shared by two natural fibers

Volume ratio;

Fiber = 30%

Resin = 50%

Plastic = 20%

Volume of resin = $210 \times 0.5 = 105\text{g}$

Volume of plastic = $196.98 \times 0.2 = 39.396\text{g}$

Volume of fiber = $193.6 \times 0.3 = 58.086\text{g}$

Density of resin = 1.2g/cc

Density of fiber = 10g/cc

Density of plastic = 0.92g/cc

weight of the fiber = density of the fiber x volume of the mould

Weight of the fiber = volume of the fiber x density of the fiber

$$= 58.086 \times 10$$

$$= 580.86 \text{ g}$$

Weight of the resin = volume of resin x density of resin

$$= 105 \times 1.2$$

$$= 126\text{g}$$

Weight of the plastic = volume of plastic x density of plastic

$$= 39.396 \times 0.92$$

Weight of the plastic = 36.24456g

Density of composite = volume of fiber x density of the fiber = $(0.3 \times 58.086) + (0.5 \times 1.2)$

$$= 18.018\text{g}$$

Flexural test:

Flexural test is also known as bending test and consists in applying a point load at the center of composites material specimen. The flexural tests were done on the universal testing machine according

to astmd790 with the crosshead speed of 10 mm/min. According to the astmd790 standard the dimensions of specimen used are shows the flexural testing astdm-d790 size of (100x12.5x10) machine with specimen.

$$\text{Flexural stress} = \frac{3pl}{2bd^2}$$

Where;

p = brake load

b = width of specimens (mm)

d = thickness of the specimen

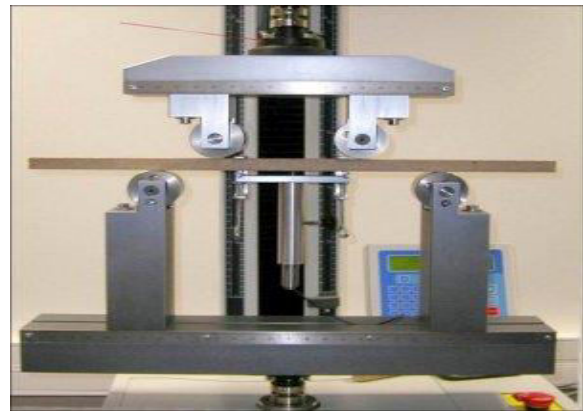

Fig: flexural testing machine

tensile test:

The tensile test specimen is prepared according to the astm d6368 standard and the machine specifications are also chosen according to the astm d6368.



Fig: tensile testing machine

4. RESULTS AND DISCUSSIONS

4.1 mechanical characteristics of composites:

The usage of natural fiber reinforced hybrid composites in different fields like aerospace, automobiles and other light weight applications has been increasing day by day due to their improved properties. In this part the investigation of the mechanical properties of reinforced hybrid composites of long continuous of different fiber weight fractions and their influence on the mechanical properties is carried out. The mechanical tests performed on the samples are:

- A. Impact test
- B. Flexural test

Results of mechanical properties of hybrid composites:

Table4.1: tensile properties of coconut fiber/ plastic hybrid composites

orientation	maximum strain (mpa)	% elongation	Tensile strength (mpa)
90 ⁰	117.7	118.7	56.3

Table4.2: tensile properties of coconut fiber and bamboo / plastic hybrid composites

% weight fraction (p/b)	orientation	maximum strain (mpa)	% elongation	Tensile strength (mpa)
40/60	90 ⁰	54.8	56.5	52.6

Tensile test graphs generated directly from computer

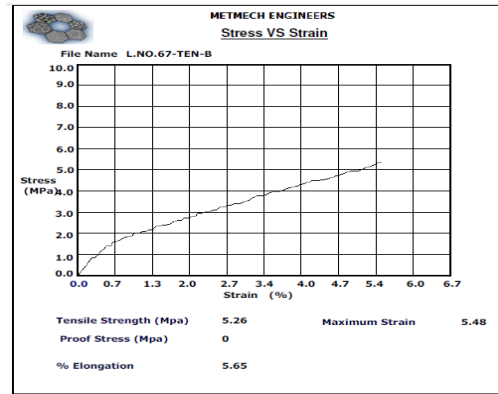
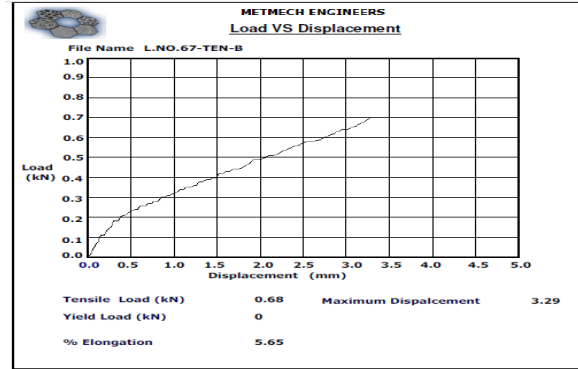

Comparison graphs of tensile test

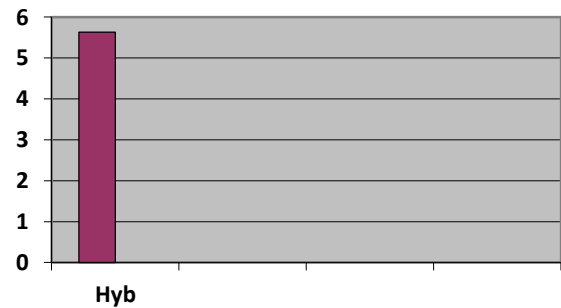

Fig: graph of tensile strength of 90⁰ orientation fibers with coconut fiber / plastic

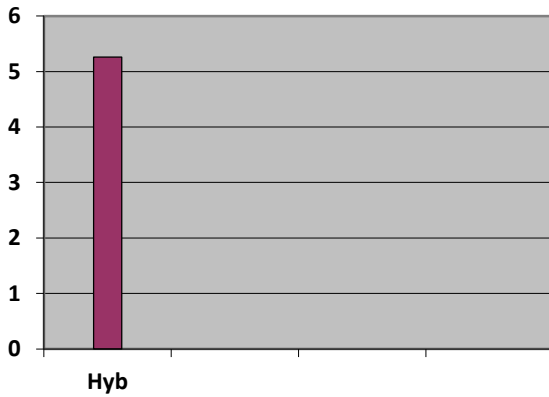
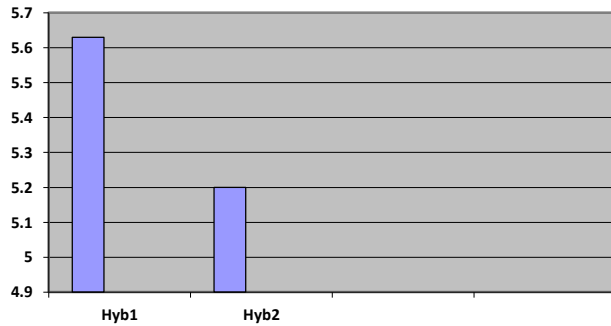

Fig: graph of tensile strength of 90° orientation fibers with coconut fiber and bamboo / plastic

Combination of both graphs:



From shows the tensile strength behavior of various composites with 40/60 weight fractions. It can be observed that tensile properties of coconut fiber / plastic hybrid composites shows a tensile strength of 5.63 mpa and tensile properties of coconut fiber and bamboo / plastic hybrid composites shows a tensile strength of 5.21 mpa respectively in 90°orientation . Which is high when compared other fiber like banana and pine apple

Table4.3: flexural properties of coconut fiber/ plastic hybrid composites

% weight fraction (p/b)	Orientation	brake load (n)	flexural strength
40/60	90°	540.000	575

table4.4: flexural properties of coconut fiber and bamboo / plastic hybrid composites

% weight fraction (p/b)	Orientation	brake load (n)	flexural strength
40/60	90°	200.000	433.15

Flexural tests graphs generated directly from computer

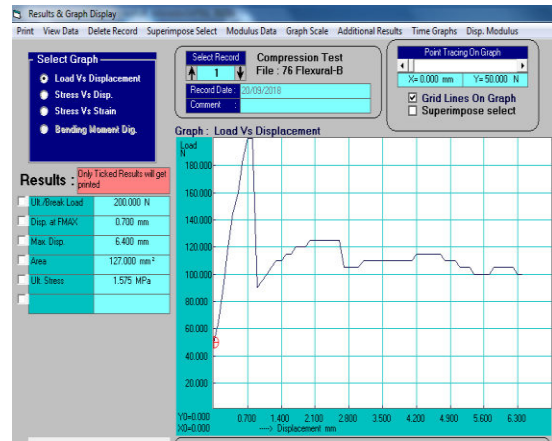

fig: graph of flexural strength of 90° orientation fibers with coconut fiber / plastic

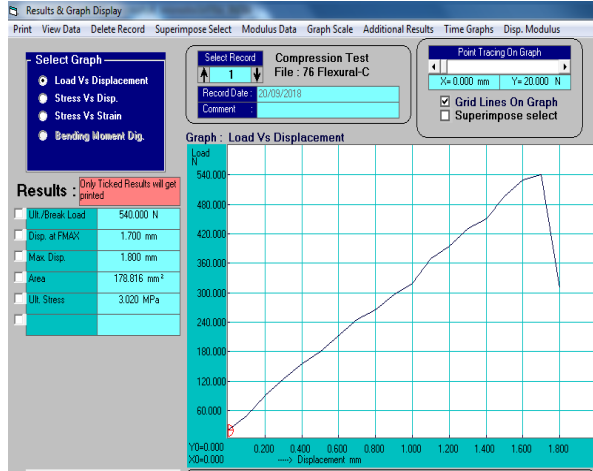

Fig: graph of flexural strength of 90⁰ orientation fibers with coconut fiber / plastic

Comparison graphs of flexural test;

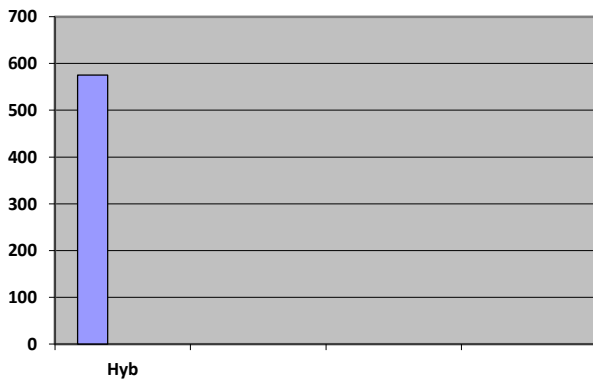

Fig: graph of flexural strength of 90⁰ orientation fibers with coconut fiber / plastic

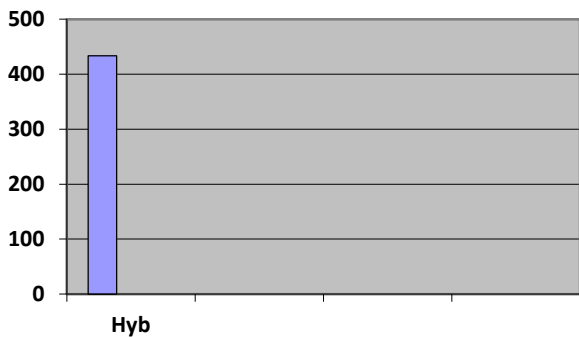
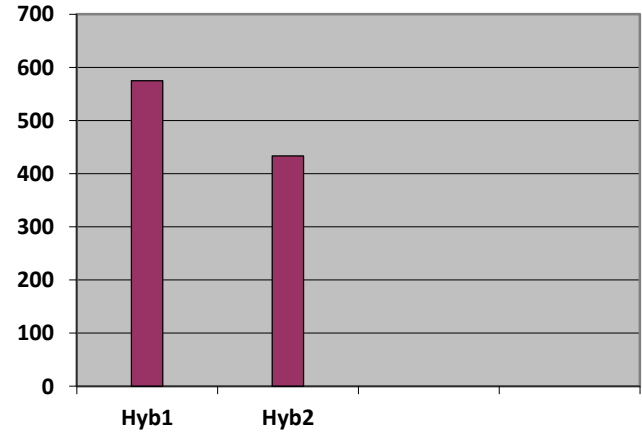

Fig: graph of flexural strength of 90⁰ orientation fibers with coconut fiber / plastic

Combination of both graphs:



From shows the flexural strength behavior of various composites with 40/60 weight fractions. It can be observed that flexural properties of coconut fiber / plastic hybrid composites shows a flexural strength of 575 mpa and tensile properties of coconut fiber and bamboo / plastic hybrid composites shows a flexural strength of 433.75 mpa respectively in 90⁰orientation . Which is high when compared other fiber like banana and pine apple

5. CONCLUSION AND FUTURE SCOPE

In the present investigation, coconut fiber, bamboo and plastic reinforced hybrid composites are prepared with the weight fraction of composites. Mechanical properties such as tensile, flexural strength are evaluated as per the astm standards.

Now days the plastic is one of the most used material in world wide. There are advantages and disadvantages of plastic, but the disadvantages are more than advantages. The most serious disadvantages of plastic is, it take too many years to decompose more than 400 years and this is too much. So there is need of recycle the plastic to reuse and to decrease the use of plastic. This product is used for cutting and crushing plastic in small pieces to make waste management easier. We are making this project model for recycling of plastic wastage in domestic area, industries etc. In this areas the plastic waste is present in large quantity. But the available machines used to recycle this waste are very costly. So our intension behind this project is to process the plastic

waste as cheap as possible by shredding. Benefits of this machine are the reduction of labor work which results in cost reduction. So we are going to design this for shred the plastic waste, with the help of blades.

CONCLUSION:

The following conclusions have been drawn from the experimental study on coconut fiber, bamboo, and plastic reinforced hybrid composites:

A hand lay-up process has been successfully used to produce a hybrid composite reinforced with plastic, bamboo, and coconut fiber.

A low-cost, lightweight, and environmentally friendly material, the hybrid composite is reinforced with plastic, bamboo, and coconut fiber within an epoxy matrix.

It is recommended to employ the coconut fiber and plastic reinforced hybrid composite sample, since it exhibits a maximum tensile strength of 56.3 mpa, in comparison to 51.9 mpa for pineapple fiber.

Tensile strength in hybrid cases is lower than in pure cases.

At 900 hybrid natural fiber composite, the maximum flexural strength is 575 mpa.

In comparison to pure natural fiber composites, hybrid natural fiber composites (coconut fiber, bamboo, and plastic reinforced hybrid composites) have good flexural strength.

Future scope of the work:

- The project is extended by doing the experimental analysis & sem analysis on different proportions of fiber content.
- The thermal properties samples can be tested.
- The other properties of composites such as moisture absorption, fatigue behavior can be determined.

References

[1] k. Bhavani & k. Hemachandra reddy,et.al(2016), mechanical behavior of banana and pineapple hybrid composites reinforced with epoxy resin, ijmetr, vol.3 (12),pp 322-329

[2] m. Ramesh ,et.al,(2016), mechanical property analysis of kenaf – glass fiber reinforced polymer composites using finite element analysis, elsevier, vol.39(1),pp 147-157

[3] ayo aw, olukunle oj, adelabu dj (2017) development of a waste plastic shredding machine. Int j waste resource 7: 281.,doi: 10.4172/pp.2252-5211.1000281

[4] meting e, erozturk a, neyim c (2003) solid waste management practises and review of recovery and recycling operations in turkey. Waste management,23: pp.425-432

[5] shilpi s, monika s (2013) eco-architecture: pet bottle houses. International journal of scientific engineering and technology 2: pp.1243-1246.

[6] puttaraj mh, shanmukha s (2005) utilization of waste plastic in manufacturing of plastic-soil bricks. International journal of technology enhancements and emerging engineering research 2: pp.2347-4289.

[7] mulla irfan faiyyaj et al, adarsh institute of technology, vita.design and development of plastic shredding machine, international journal of engineering technology science and research,ijetsr,issn 2394 – 3386, volume 4, issue 10, october 2017,pp.243-256.

[8] winandy je, stark nm, clemons cm (2004) consideration in recycling of wood- plastic composites. 5th global wood and natural fiber composites symposium. Kassel, germany

[9]m. Ramachandran, et al, mpstme, svkm nmims university. Analysis of bamboo fiber composite with polyester and epoxy resin , international journal on textile engineering and processes, issn: pp.2395-3578 .vol 1, issue 4, october 2015